

AZbeton



Cenník 2025

BETÓNOVÉ VÝROBKY

FAREBNÉ PREVEDENIE

HLADKÝ POVRCH

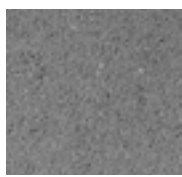

1 SIVÁ



2 ČERVENÁ



3 ŽLTÁ



4 ŠKORICOVÁ

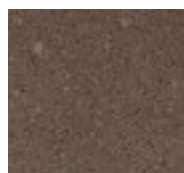

5 HNEDÁ

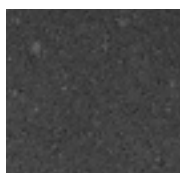

6 ČIERNA



7 BIELA

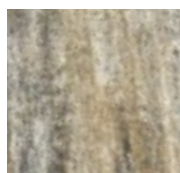

COLORMIX C1 – C10

RELIÉFNY POVRCH



RELIÉFNY POVRCH



RELIÉFNY POVRCH



RELIÉFNY POVRCH

HYDRO POVRCH



HISTORY POVRCH



HRUBOZRNNÝ POVRCH



ŠTIEPANÝ POVRCH



1 SIVÁ



2 ČERVENÁ

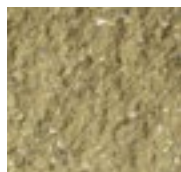

3 ŽLTÁ



4 ŠKORICOVÁ



5 HNEDÁ

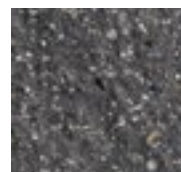

6 ČIERNA

FAZETY



KLASIK
6×3,5 mm



MALÁ FAZETA
3×3 mm



MIKROFAZETA
1×1 mm



MARKET



HISTORY

COLORMIX



COLORMIX 1
BRILANT



COLORMIX 2
SILVER

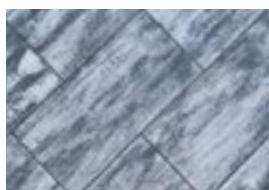

COLORMIX 3
ANTRACIT



COLORMIX 4
NATURA



COLORMIX 5
MOKA

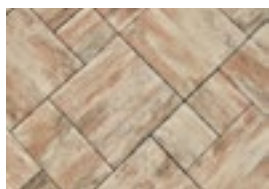

COLORMIX 6
TERAKOTA

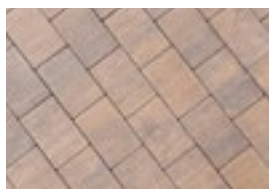

COLORMIX 7
ARABICA

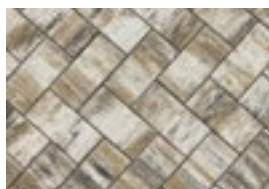

COLORMIX 8
AURUM



COLORMIX 9
BRONZ



COLORMIX 10
SAND

OBSAH

Úvod	2
Dlažby	4
Dlažba plošná	7
Dlažba vodopropustná.....	7
Dlažba vegetačná	7
Dlažba vibroliata.....	8
Odvodňovacie žľaby	8
Záhonový systém Spektra	8
Obrubníky zahradné, chodníkové, parkové	9
Obrubníky cestné, betónová príďlažba	9
Obrubníky zastávkové	10
Palisády	10
Schodiskové stupne	11
Plotový systém	11
Tvárnice debniace	12
Bloky 20 s fazetou	12
Tvarovky murovacie s hladkým povrchom	12
Tvárnice murovacie	12
Plotové tvárnice Grand	12
Tvarovky štiepané	13
Plotové striešky k štiepaným tvarovkám	13
Plotové striešky, stípkové hlavice	13
Svahové tvárnice	14
Fasádny obklad	14
Komínové tvárnice, stípkové tvárnice	14
Balenie, vrátenie paliet	14
Upozornenie	15
Ukázkové varianty pokládky	16
Návody	18



VYSVETLIVKY



chemická odolnosť, mrazuvzdornosť, dlhá životnosť



hĺbková impregnácia (celý sortiment)



hĺbková impregnácia EXTRA (ColorMix) – **NOVINKA**

IMPREGNÁCIA



DLAŽBA BEZ IMPREGNÁCIE











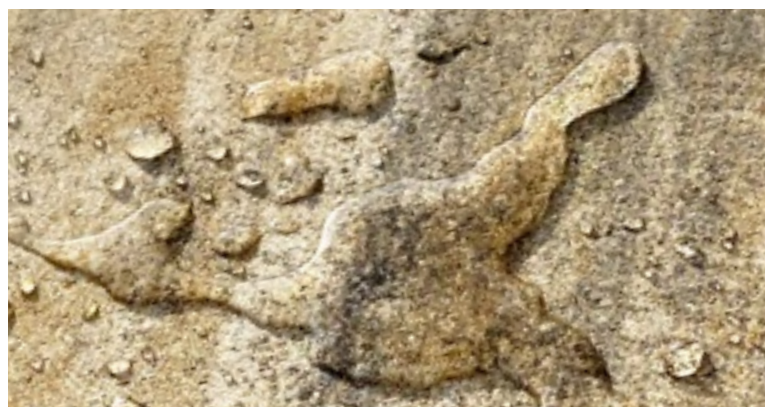







DLAŽBA IMPREGNOVANÁ





Tlačové chyby a zmeny vyhradené.

IMPREGNÁCIA EXTRA COLORMIX

Hĺbková impregnácia bráni prieniku vody a nečistôt. Výrobky sú potom menej náchylné na tvorbu vápených výkvetov, zazelenaniu povrchov a majú vyššiu odolnosť proti pôsobeniu mrazu a posypových solí. Všetky povrchy ColorMix sú navyše ošetrené impregnáciou EXTRA, ktorá zväzťuje farby a predlžuje životnosť.









VÝROBOK		Rozmer	Spotreba	Na paletu	Sivá		Farebné prevedenie		Farebnosť
		(d × š × v) mm	ks/m ² kg/m ²	m ² kg	€/m ²	€/m ²	€/m ²	€/m ²	
BEHATON		198×162×40	36 90	11,67 1050	12,10	14,88	14,90	18,33	2-6
BEHATON pre strojovú pokládku		198×162×100	36 225	6,42 1445	19,00	23,37	21,60	26,57	2-7
		198×162×80	36 180	7,34 1321	16,40	20,17	19,55	24,05	
		198×162×60	36 135	10,10 1364	13,80	16,97	16,30	20,05	
BEHATON MARKET		198×162×80	36 180	6,67 1201	17,60	21,65	20,75	25,52	2-7
		198×162×60	36 135	9,17 1238	15,40	18,94	18,05	22,20	
BEHATON krajovka		198×140×100	- 225	231 ks 1300	0,57	0,70	0,63	0,77	2-7
		198×162×80	- 180	224 ks 1260	0,52	0,64	0,57	0,70	2-6
		198×162×60	- 135	330 ks 1340	0,48	0,59	0,53	0,65	2-6
BEHATON 1/2		99×162×80	72 180	576 ks 1440	0,28	0,34	0,32	0,39	2-6
		99×162×60	72 135	792 ks 1485	0,25	0,31	0,30	0,37	
BEHATON MARKET 1/2		99×162×80	72 180	576 ks 1440	0,28	0,34	0,32	0,39	2-6
		99×162×60	72 135	792 ks 1485	0,25	0,31	0,30	0,37	
		200×100×100	50 225	5,76 1296	19,00	23,37	21,60	26,57	
HOLAND KLASIK		200×100×80	50 180	7,68 1382	16,40	20,17	19,55	24,05	2-7
		200×100×60	50 135	10,56 1426	13,80	16,97	16,30	20,05	
		200×100×40	50 90	12,48 1123	12,10	14,88	14,90	18,33	
HOLAND MARKET		200×100×80	50 180	7,68 1382	17,60	21,65	20,75	25,52	2-7
		200×100×60	50 135	10,56 1426	15,40	18,94	18,05	22,20	2-7
		200×100×45	50 100	12,48 1248	13,00	15,99	14,90	18,33	2-6
HOLAND HISTORY		200×100×60	50 135	10,56 1426	21,00	25,83	24,00	29,52	2-6
HOLAND PRE NEVIDIACICH		200×100×80	50 180	7,68 1382	27,50	33,83	29,40	36,16	2, 6
		200×100×60	50 135	10,56 1426	24,50	30,14	27,15	33,39	2, 6, 7
KOCKA 20×20 VODIACE DRÁŽKY		200×200×80	25 180	7,68 1382	27,00	33,21	29,75	36,59	2, 6
		200×200×60	25 135	10,56 1426	25,85	31,80	28,40	34,94	
KOCKA 30×30 KLASIK		300×300×80	11,1 180	8,65 1557	17,40	21,40	21,40	26,32	2-7
		300×300×60	11,1 135	10,90 1471	15,00	18,45	17,55	21,59	2-6
		300×300×45	11,1 100	13,00 1300	14,40	17,71	16,15	19,86	2-7
KOCKA 20×20 KLASIK		200×200×80	25 180	7,68 1382	17,50	21,53	19,80	24,35	2-7
		200×200×60	25 135	10,56 1426	13,80	16,97	16,30	20,05	
KOCKA 10×10 KLASIK		100×100×80	100 180	7,68 1382	16,85	20,72	19,80	24,35	2-6
		100×100×60	100 135	10,56 1426	13,85	17,04	17,40	21,40	
KOCKA 30×30 MARKET		300×300×80	11,10 180	8,65 1557	18,00	22,14	21,45	26,38	2-7
KOCKA 20×20 MARKET		200×200×80	25 180	7,68 1382	18,00	22,14	20,50	25,22	2-7
		200×200×60	25 135	10,56 1426	15,95	19,62	18,70	23,00	

VÝROBOK	 	Rozmer	Spotreba	Na palete	Sivá	Farebné prevedenie		Farebnosť			
		(d × š × v) mm	ks/m ² kg/m ²	m ² kg	€/m ²	€/m ²	€/m ²	€/m ²			
UNIDEKOR		230×140×80	38 180	8,42 1516	17,85	21,96	20,75	25,52	2-6		
		230×140×60	38 135	10,53 1422	15,65	19,25	18,05	22,20			
UNIDEKOR krajovka		230×90×60	- 135	440 ks 1300	0,50	0,61	0,54	0,66	2-6		
UNI		222×111×100	39 225	6,28 1413	20,95	25,77	23,70	29,15	2, 6		
		222×111×60	39 135	9,87 1332	15,65	19,25	18,05	22,20	2-6		
VLNKA		222×111×60	39 135	9,87 1332	15,65	19,25	18,05	22,20	2-6		
VÝROBOK	 	Rozmer	Spotreba	Na palete	Sivá	Farebné prevedenie 2-7		ColorMix 			
		(d × š × v) mm	ks/m ² kg/m ²	m ² kg	€/m ²	€/m ²	€/m ²	€/m ²			
BRANDENBURGER*		140×70×60	- 135								
		140×140×60	- 135	10,35 1397	16,00	19,68	18,80	23,12	22,20 I C1 C4 C7	27,31 I C1 C4 C7	
		140×210×60	- 135								
MOZAIKA*		110×60-135	- 135	10,13 1368	16,20	19,93	-	-	-		
VÝROBOK	 	Rozmer	Spotreba	Na palete	Sivá	Farebné prevedenie 2, 6		ColorMix 			
ROCHUZ (mikrofazeta)	NOVINKA		160×240×100	26 225	5,76 1296	21,00	25,83	24,00	29,52	-	-
VÝROBOK	 	Rozmer	Spotreba	Na palete	Sivá	Farebné prevedenie 2-6		ColorMix 			
ROCHUZ MARKET		160×240×60	26 135	10,56 1426	16,70	20,54	20,00	24,60	23,45 I C1 C2 C4 C7	28,84 I C1 C2 C4 C7	
		160×160×60	39 135	11,26 1520	16,70	20,54	20,00	24,60			
ROCHUZ HISTORY		160×240×80	26 180	7,40 1332	22,50	27,68	25,80	31,73	-	-	
		160×240×60	26 135	10,56 1426	21,00	25,83	24,00	29,52	-	-	
		160×160×60	39 135	11,26 1520	21,00	25,83	24,00	29,52	-	-	
VÝROBOK	 	Rozmer	Spotreba	Na palete	Sivá	Farebné prevedenie 2-7		ColorMix 			
BUCHLOV*		132×191×60	- 135								
		149×191×60	- 135	9,24 1247	16,00	19,68	19,50	23,99	22,70 I C3 C4 C7 C10	27,92 I C3 C4 C7 C10	
		225×191×60	- 135								
TREND *		300×300×60	- 135								
		200×300×60	- 135								
		200×200×60	- 135	10,56 1426	17,50	21,53	-	-	24,20 I C2 C3 C4 C5 C6 C8 C9 C10	29,77 I C2 C3 C4 C5 C6 C8 C9 C10	
		200×100×60	- 135								

* predaj po vrstvách

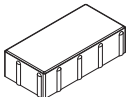
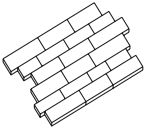
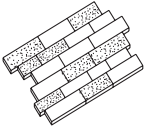
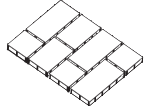
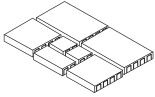
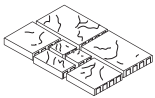
** pri farebnom prevedení BIELA účtujeme k cene bez DPH príplatok € 1,40/m²

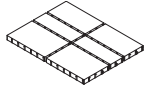
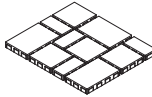
cena bez DPH cena s DPH

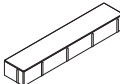



VÝROBOK		Rozmer	Spotreba	Na palete	Sivá	Farebné prevedenie 2, 6		ColorMix 		
		(d × š × v) mm	ks/m ² kg/m ²	m ² kg	€/m ²	€/m ²	€/m ²	€/m ²	€/m ²	€/m ²
PALLADIO (malá fazeta)		300×150×80	22,22 180	7,20 1296	18,80	23,12	21,50	26,45	25,00 I C2 C5 C8 C9	30,75 I C2 C5 C8 C9
LINEA* (mikrofazeta)		240, 270, 330, 360×130×60	- 135	11,88 1604	17,50	21,53	-	-	24,20 I C2 C8 C9	29,77 I C2 C8 C9
		360, 390, 450×150×60	- 135							
		360, 390, 450×170×60	- 135							
LINEA KOMBI * (mikrofazeta)		240, 270, 330, 360×130×60	- 135	11,88 1604	17,50	21,53	-	-	24,20 I C2 C3 C4 C10	29,77 I C2 C3 C4 C10
		360, 390, 450×150×60	- 135							
		360, 390, 450×170×60	- 135							
CREATIV* (mikrofazeta)		600×300×60	- 135	11,88 1604	17,50	21,53	-	-	24,20 I C2 C3 C4 C5 C8 C9 C10	29,77 I C2 C3 C4 C5 C8 C9 C10
		450×300×60	- 135							
		300×300×60	- 135							
BECKOV MARKET*		600×400×60	- 135	10,56 1426	17,50	21,53	-	-	24,20 I C2 C4 C6 C9 C10	29,77 I C2 C4 C6 C9 C10
		400×400×60	- 135							
		400×200×60	- 135							
		200×200×60	- 135							
BECKOV*		600×400×60	- 135	10,56 1426	17,50	21,53	-	-	24,20 I C2 C5 C8	29,77 I C2 C5 C8
		400×400×60	- 135							
		400×200×60	- 135							
		200×200×60	- 135							
ČACHTICE*		- 12 ks výška 80 mm	- 180	6,72 1210	18,80	23,12	-	-	25,00 I C3 C9	30,75 I C3 C9
HARMONY * (mikrofazeta)		600×400×80	- 180	7,56 1361	18,80	23,12	-	-	25,00 I C2 C4 C5 C8 C9 C10	30,75 I C2 C4 C5 C8 C9 C10
		600×200×80	- 180							
		600×300×80	- 180							
SIESTA * (mikrofazeta)		450×300×60	- 135	10,40 1404	17,50	21,53	-	-	24,20 I C2 C3 C4 C5 C8 C9 C10	29,77 I C2 C3 C4 C5 C8 C9 C10
		300×300×60	- 135							
		300×150×60	- 135							
VÝROBOK		Rozmer	Spotreba	Na palete	Sivá	Farebné prevedenie 6		ColorMix 		
		Rozmer	ks/m ² kg/ks	ks kg	€ ks	€ ks	€ ks	€ ks	€ ks	€ ks
OPTIMA (malá fazeta)		800×160×100	7,80 28	42 1176	7,35	9,04	8,25	10,15	9,60 I C2 C3 C5 C9	11,81 I C2 C3 C5 C9

* predaj po vrstvách

cena bez DPH cena s DPH

DLAŽBA PLOŠNÁ

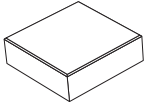
Skupina A





VÝROBOK	 	Rozmer	Spotreba	Na palete	Sivá	Farebné prevedenie 2-6		ColorMix 		
		(d × š × v) mm	ks/m ² kg/m ²	m ² kg	€/m ²	€/m ²	€/m ²	€/m ²	€/m ²	€/m ²
DLAŽBA PLOŠNÁ		600×400×80	4,17 180	7,70 1386	21,20	26,08	24,50	30,14	-	-
		500×500×80	4 180	7 1260	20,10	24,72	23,70	29,15	-	-
		500×500×60	4 135	10 1350	17,30	21,28	20,00	24,60	-	-
		800×400×50 malá fazeta	3,13 110	7,68 845	20,00	24,60	-	-	29,00 C2 C3 C4 C5 C8 C9	35,67 C2 C3 C4 C5 C8 C9
		NOVINKA								
		Rozmer	Spotreba	Na palete	Sivá	Farebné prevedenie 2-7		ColorMix 		
		(d × š × v) mm	ks/m ² kg/m ²	m ² kg	€/m ²	€/m ²	€/m ²	€/m ²	€/m ²	€/m ²
		500×500×50 malá fazeta	4 110	10 1100	16,20	19,93	18,50	22,76	29,00 C2 C4 C5 C10	35,67 C2 C4 C5 C10
		400×400×50 malá fazeta	6,25 110	7,68 845	16,20	19,93	18,50	22,76	29,00 C2 C3 C8	35,67 C2 C3 C8

*pri farebnom prevedení BIELA účtujeme k cene bez DPH príplatok € 1,40/m²

cena bez DPH cena s DPH

DLAŽBA VODOPRUPSTNÁ



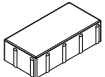

Skupina A

VÝROBOK	 	Rozmer	Spotreba	Na palete	Sivá	Farebné prevedenie 2, 6			
		(d × š × v) mm	ks/m ² kg/m ²	m ² kg	€/m ²	€/m ²	€/m ²	€/m ²	
HOLAND HYDRO 10	NOVINKA		200×100×100	50 200	5,76 1152	37,00	45,51	40,00	49,20
HOLAND HYDRO 8	NOVINKA		200×100×80	50 160	7,68 1229	34,00	41,82	38,00	46,74
HOLAND HYDRO 6	NOVINKA		200×100×60	50 120	10,56 1267	31,00	38,13	34,00	41,82
KOSTKA HYDRO 8	NOVINKA		200×200×80	25 160	7,68 1229	34,00	41,82	38,00	46,74
KOSTKA HYDRO 6	NOVINKA		200×200×60	25 120	10,56 1267	31,00	38,13	34,00	41,82
ROCHUZ HYDRO	NOVINKA		160×240×100	26 200	5,76 1152	37,00	45,51	40,00	49,20
PALLADIO HYDRO	NOVINKA		300×150×80	22 160	7,20 1152	34,00	41,82	38,00	46,74

cena bez DPH cena s DPH

DLAŽBA VEGETAČNÁ

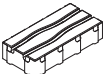



Skupina A

VÝROBOK	 	Rozmer	Spotreba	Na palete	Sivá	Farebné prevedenie	Farebnosť	ColorMix 			
		(d × š × v) mm	ks/m ² kg/m ²	m ² kg	€/m ²	€/m ²	€/m ²	€/m ²	€/m ²	€/m ²	
GALA	NOVINKA		400×200×80	12,50 145	7,68 1114	19,70	24,23	21,70	26,69	2, 6	
KARO EKO			200×200×80	25 150	7,68 1152	19,70	24,23	21,70	26,69	2-6	
PALLADIO EKO I	NOVINKA		300×150×80	22,22 147	8,64 1270	19,70	24,23	21,70	26,69	2, 6 29,60 C2 C5 C8 C9	36,40 C2 C5 C8 C9
PALLADIO EKO II	NOVINKA		300×150×80	22,22 138	8,64 1192	19,70	24,23	21,70	26,69	2, 6 29,60 C2 C5 C8 C9	36,40 C2 C5 C8 C9
		(d × š × v) mm	ks/m ² kg/ks	ks kg	€/ks	€/ks	€/ks	€/ks			
DLAŽBA ZATRÁVNŔOVACIA			600×400×100	4,17 35	32 1120	5,20	6,40	6,70	8,24	2-5	
			600×400×80	4,17 28	40 1120	3,90	4,80	5,65	6,95	2-5	

cena bez DPH cena s DPH

DLAŽBA VIBROLIATA



Skupina B

VÝROBOK		Rozmer	Spotreba	Hmotnosť	Na palete	Sivá	
		(d × š × v) mm	ks/m ² kg/m ²	kg/ks	ks	€/ks	€/ks
DOSKA 58×20×4		580×200×40	8,60 83	10	kusový predaj	7,00	8,61
DOSKA 79×35×5		790×350×50	3,61 100	28	kusový predaj	8,10	9,96
DOSKA 79×19×5		790×190×50	6,66 100	15	kusový predaj	4,35	5,35



cena bez DPH cena s DPH

ODVODŇOVACIE ŽLABY

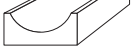
Skupina B

VÝROBOK		Rozmer	Spotreba	Na palete	Sivá			
ŽLABY VIBROLIATE		(d × š × v) mm	ks/bm kg/ks	ks	€/ks	€/ks	€/ks	€/ks
ODVODŇOVACÍ ŽLAB veľký		350×250×80	2,80 12	kusový predaj	3,80	4,67	-	-
ODVODŇOVACÍ ŽLAB malý		255×160×80	3,90 6	kusový predaj	3,45	4,24	-	-



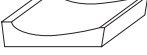

Skupina A

ŽLABY VIBROLISOVANÉ		Rozmer	Spotreba	Na palete	Sivá		Čierna
		(d × š × v) mm	ks/bm kg/ks	ks/kg	€/ks	€/ks	€/ks
ŽLAB ODVODŇOVACÍ 50		500×250×100	2 25	48 1200	4,60		5,66
CESTNÝ ŽLAB ODVODŇOVACÍ 33		330×650×160	3 43	24 1032	4,35		5,35
CESTNÝ ŽLAB ODVODŇOVACÍ 25		250×500×120	4 25	36 900	3,10		3,81

cena bez DPH cena s DPH

ZÁHONOVÝ SYSTÉM SPEKTRA

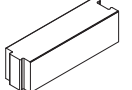
Skupina B

VÝROBOK	 	Rozmer	Hmotnosť	Na palete	Sivá		Čierna	
		(d × v × š) mm	kg/ks	ks/kg	€/ks	€/ks	€/ks	€/ks
ZÁHONOVÝ SYSTÉM SPEKTRA, priebežný	NOVINKA 	500×150×140	22	48 1056	5,00	6,15	5,40	6,64
ZÁHONOVÝ SYSTÉM SPEKTRA, rohový	NOVINKA 	600×150×140	32	32 1024	6,40	7,87	7,00	8,61

cena bez DPH cena s DPH

OBRUBNÍKY ZAHRADNÉ, CHODNÍKOVÉ, PARKOVÉ

Skupina B

VÝROBOK		Rozmer	Spotreba	Na palete	Sivá		Farebné prevedenie 2-5	
		(d × v × š) mm	ks/bm kg/ks	ks/kg	€/ks	€/ks	€/ks	€/ks
OBRUBNÍK ZÁHRADNÝ P+D 20 POLOGULATÝ		500×200×50	2 10	90 900	1,90	2,34	-	-
OBRUBNÍK ZÁHRADNÝ P+D 20 ROVNÝ		500×200×50	2 10	90 900	1,90	2,34	-	-
OBRUBNÍK ZÁHRADNÝ P+D 20 ROVNÝ, DLHÝ		1000×200×50	1 20	48 960	3,38	4,16	-	-
OBRUBNÍK ZÁHRADNÝ P+D 25 ROVNÝ, DLHÝ		1000×250×50	1 25	45 1125	3,85	4,74	-	-
OBRUBNÍK ZÁHRADNÝ P+D 20 GULATÝ		500×200×50	2 10	90 900	1,90	2,34	2,50	3,08
OBRUBNÍK ZÁHRADNÝ P+D 25 GULATÝ		500×250×50	2 12,5	90 1125	2,25	2,77	-	-
OBRUBNÍK ZÁHRADNÝ P+D 20 GULATÝ, DLHÝ		1000×200×50	1 20	48 960	3,38	4,16	4,40	5,41
OBRUBNÍK ZÁHRADNÝ P+D 25 GULATÝ, DLHÝ		1000×250×50	1 25	45 1125	3,85	4,74	-	-
OBRUBNÍK CHODNÍKOVÝ rovný 25		1000×250×100	1 54	24 1296	6,00	7,38	-	-
OBRUBNÍK CHODNÍKOVÝ skosený		1000×250×100	1 51	24 1224	6,00	7,38	-	-
OBRUBNÍK CHODNÍKOVÝ rovný 20		1000×200×100	1 43	24 1032	5,75	7,07	-	-
OBRUBNÍK PARKOVÝ		1000×250×75	1 40	30 1200	5,40	6,64	-	-
		(d × š × v) mm	ks/bm kg/ks	ks kg	€/ks	€/ks	€/ks	€/ks
TRÁVNIKOVÝ LEM		330×160×50	3 5	200 1000	1,10	1,35	1,35	1,66

cena bez DPH cena s DPH

OBRUBNÍKY CESTNÉ, BETÓNOVÁ PRÍDLAŽBA



Skupina B

VÝROBOK		Rozmer	Spotreba	Na palete	Sivá	
		(d × v × š) mm	ks/bm kg/ks	ks/kg	€/ks	€/ks
OBRUBNÍK CESTNÝ 30		1000×300×150	1 96	15 1440	8,90	10,95
OBRUBNÍK CESTNÝ 25		1000×250×150	1 80	15 1200	6,80	8,36
OBRUBNÍK CESTNÝ 25 PREMIUM		1000×250×150	1 80	15 1200	6,80	8,36
OBRUBNÍK CESTNÝ 25 ROVNÝ		1000×250×150	1 80	15 1200	6,80	8,36
OBRUBNÍK CESTNÝ 1/2		500×250×150	2 40	32 1280	5,00	6,15
OBRUBNÍK CESTNÝ 1/3		330×250×150	3 27	30 810	4,20	5,17
OBRUBNÍK CESTNÝ 1/3 PREMIUM		330×250×150	3 27	30 810	4,20	5,17
OBRUBNÍK NÁJAZDOVÝ		1000×150×150	1 50	24 1200	6,50	8,00
OBRUBNÍK PRECHODOVÝ L+P		1000×250/150×150	1 65	9+9 1170	22,35	27,49

cena bez DPH cena s DPH

OBRUBNÍKY CESTNÉ, BETÓNOVÁ PRÍDLAŽBA



Skupina A

VÝROBOK	 	Rozmer	Spotreba	Na palete	Sivá	
		(d × š × v) mm	ks/bm kg/ks	ks kg	€/ks	€/ks
BETÓNOVÁ PRÍDLAŽBA		500×250×100	2 29	48 1392	3,40	4,18
		500×250×80	2 23	48 1104	3,15	3,87

cena bez DPH cena s DPH

OBRUBNÍKY ZASTÁVKOVÉ



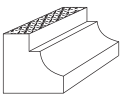
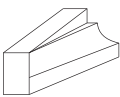
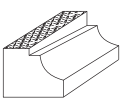





Skupina B

VÝROBOK	 	Rozmer	Hmotnosť	Na palete	Sivá	
		(d × š × v) mm	kg/ks	ks/kg	€/ks	€/ks
OBRUBNÍK ZASTÁVKOVÝ priamy 29		1000×400×290	224	3 672	129,20	158,92
OBRUBNÍK ZASTÁVKOVÝ priamy 33		1000×400×330	242	3 726	129,20	158,92
OBRUBNÍK ZASTÁVKOVÝ priamy 37		1000×400×370	261	3 783	129,20	158,92
OBRUBNÍK ZASTÁVKOVÝ prechodový 25-29 Ľ		1000×400×250-290	147	2 294	129,20	158,92
OBRUBNÍK ZASTÁVKOVÝ prechodový 25-29 P		1000×400×250-290	147	2 294	129,20	158,92
OBRUBNÍK ZASTÁVKOVÝ prechodový 25-31 Ľ		1000×400×250-310	151	2 302	129,20	158,92
OBRUBNÍK ZASTÁVKOVÝ prechodový 25-31 P		1000×400×250-310	151	2 302	129,20	158,92
OBRUBNÍK ZASTÁVKOVÝ nábehový 31-33 Ľ		1000×400×310-330	236	2 472	129,20	158,92
OBRUBNÍK ZASTÁVKOVÝ nábehový 31-33 P		1000×400×310-330	236	2 472	129,20	158,92
OBRUBNÍK ZASTÁVKOVÝ nábehový 31-37 Ľ		1000×400×310-370	247	2 494	129,20	158,92
OBRUBNÍK ZASTÁVKOVÝ nábehový 31-37 P		1000×400×310-370	247	2 494	129,20	158,92



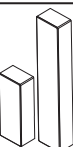

cena bez DPH cena s DPH

PALISÁDY

Skupina B

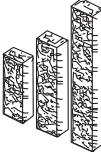

VÝROBOK	 	Rozmer	Spotreba	Na palete	Sivá		Farebné prevedenie 2-5			
		(š × v) mm	ks/bm kg/ks	ks kg	€/ks	€/ks	€/ks	€/ks	€/ks	€/ks
KRUHOVÁ PALISÁDA 50		120×500	10 13	66 858	4,05	4,98	5,15	6,33	-	-
KRUHOVÁ PALISÁDA 30		120×300	10 8	66 528	2,40	2,95	3,15	3,87	-	-
VÝROBOK	 	Rozmer	Spotreba	Na palete	Sivá		Čierna		ColorMix C2, C3, C5, C9 	
		(d × š × v) mm	ks/bm kg/ks	ks kg	€/ks	€/ks	€/ks	€/ks	€/ks	€/ks
PALISÁDA 120/12 ColorMix horizontálne		180×120×1200	5,55 57	20 1140	15,80	19,43	18,00	22,14	19,00	23,37
PALISÁDA 80/12 ColorMix horizontálne		180×120×800	5,55 38	30 1140	9,80	12,05	11,00	13,53	12,00	14,76
PALISÁDA 60/12 ColorMix horizontálne		180×120×600	5,55 28,5	40 1140	7,70	9,47	8,80	10,82	9,40	11,56
PALISÁDA 40/12 ColorMix horizontálne		180×120×400	5,55 19	60 1140	3,20	3,94	3,60	4,43	3,80	4,67
PALISÁDA 80/10 ColorMix vertikálne	NOVINKA 	160x100x800	6,25 28	42 1176	7,35	9,04	8,25	10,15	9,60	11,81
PALISÁDA 40/10 ColorMix vertikálne	NOVINKA 	160x100x400	6,25 14	84 1176	3,20	3,94	3,60	4,43	3,80	4,67

cena bez DPH cena s DPH

VÝROBOK	 	Rozmer	Spotreba	Na palete	Sivá		Čierna		ColorMix C2, C3, C5, C9 	
					(d × š × v) mm	ks/bm kg/ks	ks kg	€/ks	€/ks	€/ks
ŠTIEPANÁ PALISÁDA 80/10		150×100×800	6,66 24	40 960	10,60	13,04	13,00	15,99	-	-
ŠTIEPANÁ PALISÁDA 60/10		150×100×600	6,66 20	48 960	7,20	8,86	8,70	10,70	-	-
ŠTIEPANÁ PALISÁDA 40/10		150×100×400	6,66 13	80 1040	4,80	5,90	5,80	7,13	-	-
ŠTIEPANÁ PALISÁDA 110/15		150×150×1100	6,66 49,50	20 990	16,20	19,93	19,40	23,86	-	-
ŠTIEPANÁ PALISÁDA 60/15		150×150×600	6,66 30	36 1080	10,80	13,28	13,00	15,99	-	-
ŠTIEPANÁ PALISÁDA 40/15		150×150×400	6,66 20	56 1120	7,30	8,98	8,65	10,64	-	-



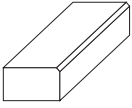
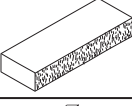
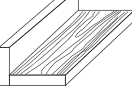

cena bez DPH cena s DPH

SCHODISKOVÉ STUPNE

VÝROBOK	 	Rozmer	Spotreba	Na palete	Sivá		Čierna	
					(d × š × v) mm	ks/bm kg/ks	ks/kg	€/ks
SCHODISKOVÝ STUPEŇ		900×340×150	- 95	8 760	24,60	30,26		
SCHODISKOVÝ STUPEŇ SO ŠTIEPANÝM ČELOM	NOVINKA 	1200×350×150	- 139	8 1112	33,95	41,76	40,60	49,94
SCHODISKOVÝ STUPEŇ TYP DOSKA		850×400×155	- 45	12 540	20,50	25,22	-	-

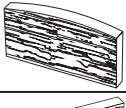
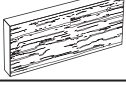
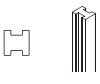
cena bez DPH cena s DPH

PLOTOVÝ SYSTÉM

VÝROBOK		Rozmer	Hmotnosť	Na palete	Sivá	
					(d × š × v) mm	kg/ks
PLOTOVÝ DIEL KAMEŇ, OBLÚKOVÝ		2000×50×610	90	kusový predaj	29,60	36,41
PLOTOVÝ DIEL KAMEŇ		2000×50×500	80	15 1200	24,60	30,26
STĽPIK PRIEBEŽNÝ		1650×160×130	58,50	kusový predaj	30,75	37,82
		2400×160×130	85	kusový predaj	44,30	54,49
		3300×160×130	117	kusový predaj	59,00	72,57
STĽPIK ROHOVÝ		2400×160×130	90	kusový predaj	44,30	54,49
STĽPIK KONCOVÝ		2400×160×130	90	kusový predaj	44,30	54,49
PODHRABOVÁ DOSKA		2500×300×45	52	15 780	19,70	24,23

Plotový systém - výrobok je určený na ďalšiu povrchovú úpravu a je armovaný.

cena bez DPH cena s DPH

TVÁRNICE DEBNIACE

Skupina B

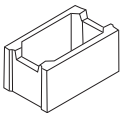
VÝROBOK		Rozmer	Spotreba	Na palete	Sivá	
		(d × š × v) mm	ks/m ² kg/ks	ks kg	€/ks	€/ks
TVÁRNICA PRESNÁ DEBNIACA 10		490×100×250	8 17	80 1360	2,10	2,58
TVÁRNICA PRESNÁ DEBNIACA 15		500×150×250	8 18	80 1440	2,10	2,58
TVÁRNICA PRESNÁ DEBNIACA 20		500×200×250	8 24	60 1440	2,30	2,83
TVÁRNICA PRESNÁ DEBNIACA 25		500×250×250	8 28	40 1120	2,55	3,14
TVÁRNICA PRESNÁ DEBNIACA 30		500×300×250	8 31	40 1240	2,66	3,27
TVÁRNICA PRESNÁ DEBNIACA 40		500×400×250	8 37	30 1110	3,11	3,83
TVÁRNICA PRESNÁ DEBNIACA 50		400×500×250	10 37	20 740	3,61	4,44

cena bez DPH cena s DPH

BLOKY 20 S FAZETOU

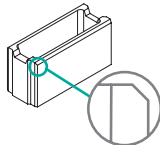

Skupina B

VÝROBOK		Rozmer	Spotreba	Na palete	Sivá	
		(d × š × v) mm	ks/m ² kg/ks	ks kg	€/ks	€/ks
BLOK 20 S FAZETOU NOVINKA		500×200×250	8 24	60 1440	2,50	3,08

cena bez DPH cena s DPH

TVAROVKY MUROVACIE S HLADKÝM POVRCHOM

Skupina B

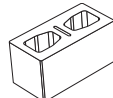
VÝROBOK	 	Rozmer	Spotreba	Na palete	Sivá		Farebné prevedenie 2-5	
		(d × š × v) mm	ks/m ² kg/ks	ks kg	€/ks	€/ks	€/ks	€/ks
TVAROVKA HLADKÁ ODĽAHCENÁ		385×190×190	13,50 18	60 1080	3,10	3,81	3,90	4,80

cena bez DPH cena s DPH

TVÁRNICE MUROVACIE



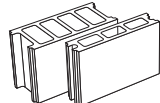





Skupina B

VÝROBOK		Rozmer	Spotreba	Na palete	Sivá	
		(d × š × v) mm	ks/m ² kg/ks	ks kg	€/ks	€/ks
TVÁRNICA MUROVACIA S DNOM		450×100×200	11,10 12,5	100 1250	1,66	2,04
		450×200×200	11,10 23	50 1150	2,60	3,20

cena bez DPH cena s DPH

PLOTOVÉ TVÁRNICE GRAND

Skupina B









VÝROBOK	 	Rozmer	Spotreba	Na palete	Sivá		Farebné prevedenie 6		ColorMix 	
		(d × š × v) mm	ks/m ² kg/ks	ks kg	€/ks	€/ks	€/ks	€/ks	€/ks	€/ks
PLOTOVÁ TVÁRNICA GRAND 20 NOVINKA		200×200×125	40 6	144 864	1,60	1,97	2,40	2,95	2,80	3,44
PLOTOVÁ TVÁRNICA GRAND 40 NOVINKA		400×200×125	20 12	72 864	2,90	3,57	3,80	4,67	5,60	6,89
PLOTOVÁ TVÁRNICA GRAND 60 NOVINKA		600×200×125	13,3 18	48 864	4,30	5,29	5,40	6,64	8,00	9,84
PLOTOVÁ TVÁRNICA GRAND, stĺpová NOVINKA		400×300×125	20 17	48 816	4,00	4,92	4,80	5,90	6,80	8,36
PLOTOVÁ STRIEŠKA GRAND malá NOVINKA		230×270×55	ks/bm kg/ks 4,3 7,5	162 1215	3,50	4,31	3,90	4,80	7,20	8,86
PLOTOVÁ STRIEŠKA GRAND veľká NOVINKA		230×370×55	ks/bm kg/ks 4,3 11	108 1188	4,00	4,92	4,70	5,78	7,92	9,74

Plotová tvárnica GRAND/ColorMix v ponuke od 1. 5. 2025

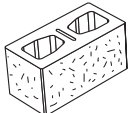
cena bez DPH cena s DPH

TVAROVKY ŠTIEPANÉ





Skupina B

VÝROBOK	 	Rozmer	Spotreba	Na palete	Sivá		Farebné prevedenie 2-6		
					(d × š × v) mm	ks/m ² kg/ks	ks kg	€/ks	€/ks
TVAROVKA 1-STRANNÁ			385×190×190	13,50 18	60 1080	3,30	4,06	3,80	4,67
TVAROVKA 2-STRANNÁ						4,40	5,41	5,00	6,15
TVAROVKA ROHOVÁ						4,70	5,78	5,20	6,40
TVAROVKA 3-STRANNÁ, stĺpová						5,90	7,26	6,50	8,00
TVAROVKA 3-STRANNÁ, koncová						5,90	7,26	6,50	8,00
TVAROVKA 4-STRANNÁ						7,00	8,61	7,70	9,47
TVAROVKA PRIMUROVACIA		385×65×190	13,50 10	150 1500	1,35	1,66	1,60	1,97	

cena bez DPH cena s DPH

PLOTOVÉ STRIEŠKY K ŠTIEPANÝM TVAROVKÁM



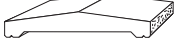



Skupina B

VÝROBOK	 	Rozmer	Spotreba	Na palete	Sivá		Farebné prevedenie 2-6 *	
					(d × š) mm	ks/bm kg/ks	ks kg	€/ks
PLOTOVÁ STRIEŠKA s odkvapovou drážkou		220×380	4,50 8,5	84 714	3,30	4,06	3,85	4,74
PLOTOVÁ STRIEŠKA so štiepaným čelom		220×300	4,50 7,4	168 1243	3,70	4,55	4,30	5,29
PLOTOVÁ STRIEŠKA veľká s odkvapovou drážkou		190×580	5,25 11	84 924	4,65	5,72	5,20	6,40
PLOTOVÁ STRIEŠKA veľká so štiepaným čelom		190×500	5,25 10	84 840	5,00	6,15	5,75	7,07

* farebné prevedenie ČIERNA - iba na objednávku





PLOTOVÉ STRIEŠKY, STĽPOVÉ HLAVICE

Skupina B

VÝROBOK	 	Rozmer	Spotreba	Na palete	Sivá		Farebné prevedenie 6		Prevedenie	ColorMix 	
					(d × š) mm	ks/bm kg/ks	ks kg	€/ks		€/ks	€/ks
PLOTOVÁ STRIEŠKA GRAND malá NOVINKA 		230×270×55	4,3 7,5	162 1215	3,50	4,31	3,90	4,80	-	7,20	8,86
PLOTOVÁ STRIEŠKA GRAND veľká NOVINKA 		230×370×55	4,3 11	108 1188	4,00	4,92	4,70	5,78	-	7,92	9,74
PLOTOVÁ STRIEŠKA vibroliata 50×18		500×180	2 9	kusový predaj	5,55	6,83	-	-	HL -		
PLOTOVÁ STRIEŠKA vibroliata 39×27		390×270	2,50 9	61 549	6,10	7,50	-	-	HL DR		
PLOTOVÁ STRIEŠKA vibroliata 39×35 		390×350	2,50 12,50	30 375	6,95	8,55	-	-	HL DR		
PLOTOVÁ STRIEŠKA vibroliata 70×46		700×460	1,40 50	kusový predaj	27,00	33,21	-	-	HL -		
STĽPOVÁ HLAVICA vibroliata 47×27		470×270	- 13	kusový predaj	9,50	11,69	-	-	HL DR		
STĽPOVÁ HLAVICA vibroliata 39×39 		390×390	- 15,50	kusový predaj	7,00	8,61	-	-	- DR		
STĽPOVÁ HLAVICA vibroliata 49×49		490×490	- 25	kusový predaj	9,95	12,24	-	-	HL DR		
STĽPOVÁ HLAVICA vibroliata 55×55		550×550	- 28	kusový predaj	10,45	12,85	-	-	HL -		

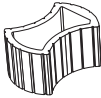

HL - hladký povrch, DR - drsný povrch

cena bez DPH cena s DPH

VÝROBOK		Rozmer	Spotreba	Na palete	Sivá	Farebné prevedenie 2-5	
		(d × š × v) mm	ks/m ² kg/ks	ks kg	€/ks	€/ks	€/ks
svahová tvárnica vario		570×385×250	10 44	20 880	8,95	11,01	10,75
svahová tvárnica kruhová		ø345 280×200	17,50 18	30 540	4,35	5,35	5,40
svahová tvárnica kruhová veľká		ø 500 420×250	9,50 45	20 900	7,20	8,86	9,00
záhradný kameň		225×200×100	50 9	140 1260	1,95	2,40	2,20





cena bez DPH cena s DPH

fasádny obklad

VÝROBOK	 	Rozmer	Spotreba	Na palete	Sivá
		(d × š × v) mm	ks/m ² kg/m ²	m ² kg	€/m ²
fasádny obklad štiepaný		220×50×35	90,90 66,36	-	22,00

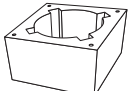
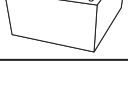
cena bez DPH cena s DPH

komínové tvárnice, stĺpkové tvárnice

VÝROBOK		Rozmer	Spotreba	Na palete	Sivá
		(d × š × v) mm	ks/bm kg/ks	ks kg	€/ks
keramzitová komínová tvárnica, ø20 cm		400×400×250	4 28	30 840	8,10
keramzitová komínová tvárnica, ø16 cm		320×320×250	4 18	40 720	7,70
betónová stĺpková tvárnica štvorcová 40		400×400×250	4 32	30 960	3,90
betónová stĺpková tvárnica štvorcová 30		300×300×250	4 20	60 1200	3,00
betónová stĺpková tvárnica štvorcová 20		200×200×250	4 12	96 1152	2,40
betónová stĺpková tvárnica kruhová		ø300×250	4 12	40 480	2,40

cena bez DPH cena s DPH

BALENIE, VRÁTENIE PALIET

Tovar expedujeme na paletách EUR.

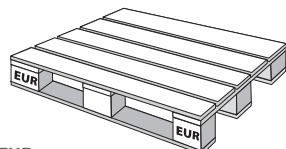

PALETA EUR

Účtované v cene pri odbere palet (od 1. 5. 2022)

15 EUR / 1 ks +DPH

Čiastka vrátená pri vrátení použitých palet a pri predložení zálohového listu na palety (od 1. 5. 2022)

13 EUR / 1 ks +DPH

ROZBALENIE PALETY

10 EUR | paleta

VRÁTENIE PALIET

Nepoškodené palety sú vratné do 3 mesiacov od expedície.

Palety je možné vracať iba pri doložení dokladu VRATKA PALET alebo ZÁLOHOVÉHO LISTU NA PALETY

Kupujúci je povinný vrátiť palety na vlastné náklady.

V prípade, ak sa domnievate, že Vám bol tovar dodaný na poškodenej palete, musí byť pri preberaní tovaru táto skutočnosť poznačená do dodacieho listu, alebo iného dokladu.

Za poškodenú sa považuje paleta so zlomenou, alebo chýbajúcou doskou, prípadne paleta, ktorej chýba niektorá ďalšia významná časť a nie je možné ju už ďalej použiť.

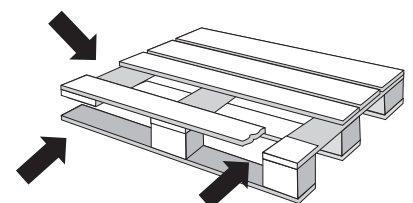

DOPRAVA

Zabezpečujeme rozvoz výrobkov vlastnými autami s hydraulickou rukou s možnosťou pripojenia návesu.

Aby sme zabránili nedorozumeniam a zamedzili zbytočným reklamáciám, prosím prečítajte si nasledovné upozornenia a rady.

„VÝKVETY“

(VYZRÁŽANIE SOLÍ A VÁPENCA NA POVRCHU BETÓNU)

Pri technologickom procese spracovania betónovej zmesi dochádza v niektorých prípadoch pri odparovaní vody k vysrážaniu vápenca na povrchu betónu. Tieto „výkvety“ **v žiadnom prípade neovplyvňujú úžitkové vlastnosti výrobku**. Pri bežných poveternostných vplyvoch počasia sa vápnik pomaly stráca, prípadne odplavuje a „výkvety“ **sa postupne po určitom čase sami stratia**. Z uvedeného vyplýva, že „výkvety“ **nemôžu byť predmetom reklamácie**.

FAREBNÉ ODCHÝLKY

Betónové výrobky sa vyrábajú z prírodných materiálov, preto sa u nich môžu vyskytnúť menšie alebo väčšie rozdiely vo farebnosti. Prírodné kamenivo, ktoré je hlavnou zložkou výrobkov, ako aj samotný cement nie sú vždy rovnaké. Práve odchýlky vo farebnosti podčiarkujú prírodný vzhľad výrobkov. Aj pôsobením svetla sa môže dlažba a betónové výrobky javiť v jemnej farebnej odlišnosti. Rozdiely vo farebnosti sa môžu prejaviť pri výrobkoch rovnakého druhu zhotovených podľa rovnakých postupov, ale nie v rovnakom čase. Farebnosť týchto výrobkov sa používaním a pod vplyvom bežných poveternostných vplyvov zvyčajne vyrovná. Z týchto dôvodov **nemôžu byť farebné rozdiely v odtieňoch dôvodom k reklámácii**.

ODPORÚČAME:

Farebné prevedenie v jednotlivých vrstvách v palete nemusí byť identické s ostatnými vrstvami. Preto pre elimináciu farebných odchýliek doporučujeme klást dlažby z viacerých paliet súčasne. Pre dosiahnutie dokonalého a vyváženého prefarbenia dláždenej plochy je potrebné dodržať tento postup. Práve náhodnosť výberu jednotlivých kusov vytvára žiadaný efekt. Nedodržaním postupu pri kladení, môžete vytvoriť plochu, ktorá nespĺní Vaše estetické očakávania.

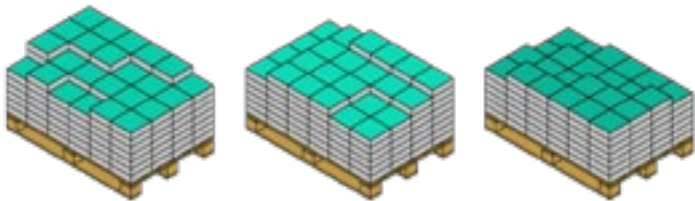

DOSTUPNOSŤ TOVARU

U farebných výrobkov v požadovanom množstve menšom, ako 1 paleta (okrem zámkovej dlažby a štiepaných tvaroviek) upresňujeme termín dodania individuálne.

OLUPOVANIE HRÁN

Ak sa betónová dlažba ukladá na doraz a spodná vrstva nie je dostatočne zhutnená, vzniká nebezpečie, že pri vibráciách a následnom zaťažení plochy budú hrany dlažby vystavené veľkému tlaku, ktorému ani betóny najvyšších tried a kvality nie sú schopné odolať. Výsledkom sú **odlomené hrany**, čo **nie je chyba výrobku**, ale chyba uloženia. Dlažba sa musí ukladať podľa technických podkladov projektanta. Dodávateľ stavebných prác tak ručí za odborné prevedenie pokládky. Dlažba sa vždy kladie do lôžka z kvalitného drveného kameniva (2–4 mm, prípadne 4–8 mm). Plné zaťaženie dlažby a ostatných betónových výrobkov je možné najskôr po 28 dňoch od dátumu výroby. **Pri nedodržaní týchto pokynov firma AZ BETON nezodpovedá za vady vzniknuté nesprávnou pokládkou, predčasným zaťažením, alebo nevhodným určením druhu dlažby pre komunikácie**. Návod na pokládku zámkovej dlažby nájdete v katalógu AZ BETON.

VIBROVANIE DLAŽIEB

Dlažby BECKOV, BECKOV MARKER, CREATIV, SIESTA, plošné dlažby (300×300 mm, 400×400 mm, 500×500 mm, 800×500 mm) a dlažby zatravnovacie nie je možné zhutniť vibračnou doskou. Dosadenie dlažby na lôžko z kameniva 4–8 mm sa prevádza gumovým kladivkom cez drevenú dosku.

REKLAMÁCIE

Reklamácie prípadných väd je možné uplatniť iba pred použitím výrobkov.



VARIANTY POKLÁDKY

BECKOV, BECKOV MARKET

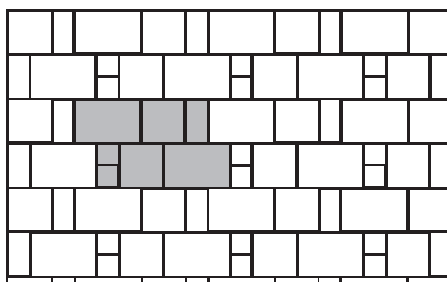

názov

BECKOV

orientačná ukážka

BECKOV, BECKOV MARKET

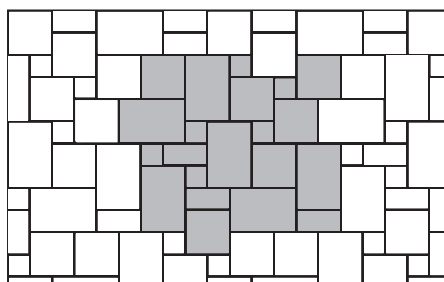

názov

BECKOV

orientačná ukážka

BRANDENBURGER

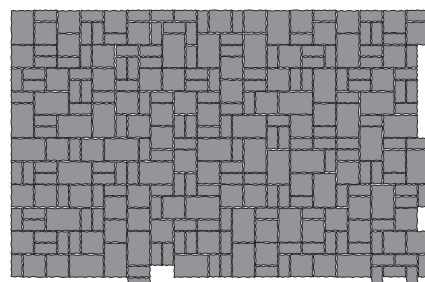

názov

BRANDENBURGER

orientačná ukážka

BUCHLOV

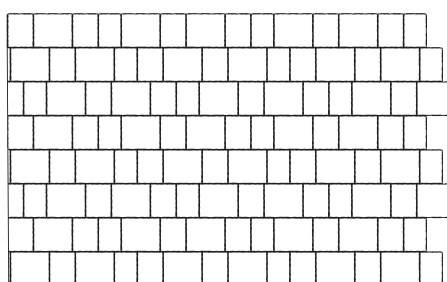

názov

BUCHLOV

orientačná ukážka

CREATIV

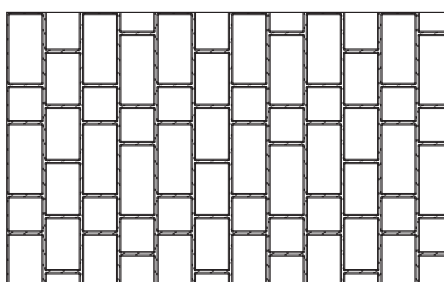

názov

CREATIV

orientačná ukážka

ČACHTICE

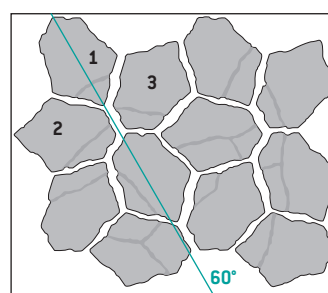

názov

ČACHTICE

pokládka

Kamene klademe v poradi 1, 2, 3 a ďalej pokračujeme tak, aby sa tri najkratšie strany vždy zbiehali v jeden bod, vid. náčres.

HARMONY

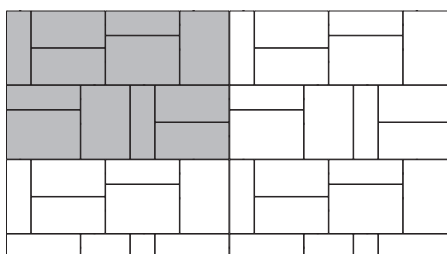

názov

HARMONY

orientačná ukážka

HARMONY

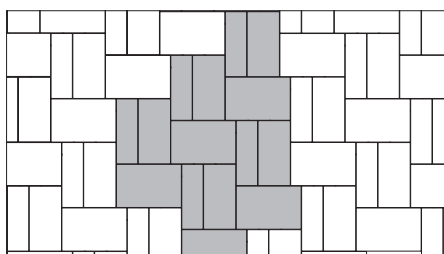

názov

HARMONY

orientačná ukážka

LINEA

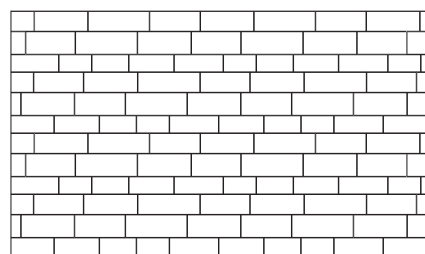

názov

LINEA

orientačná ukážka

ROCHUZ

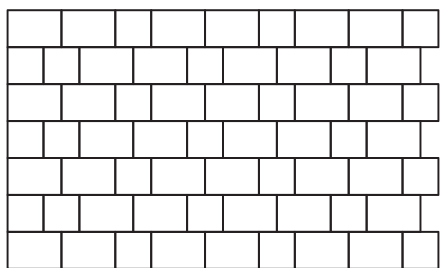

názov

ROCHUZ

rozmer
160×160

farba
-

ks
9,75

podiel (%)
25,0

ROCHUZ

rozmer
160×240

farba
-

ks
19,5

podiel (%)
75,0

SIESTA

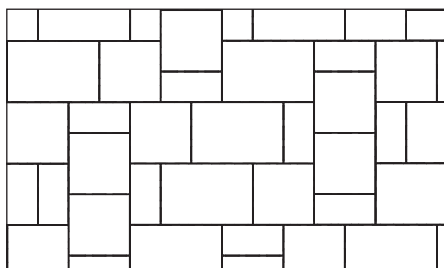

názov

SIESTA

orientačná ukážka

TREND

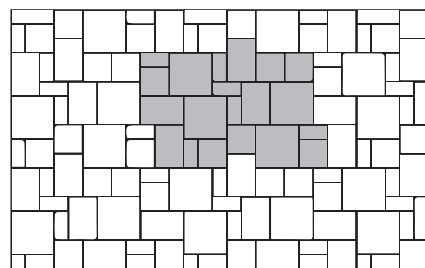

názov

TREND

orientačná ukážka

TREND

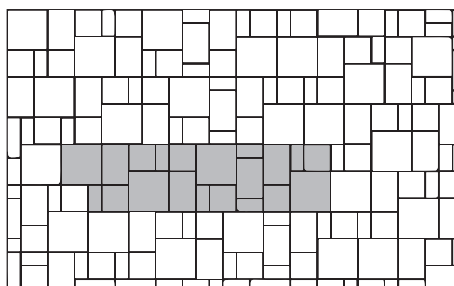

název
TREND orientáčná ukážka

GALA

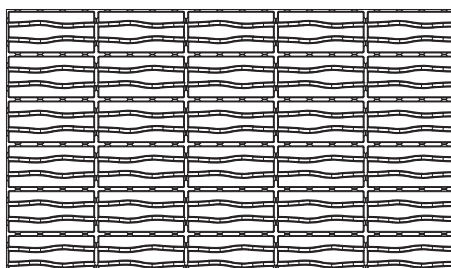

název
GALA orientáčná ukážka POMER BETÓN/ OTVOR
betón 85 % otvor 15 %

GALA

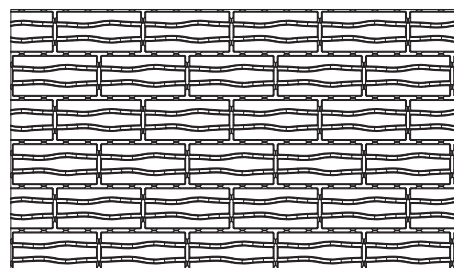

název
GALA orientáčná ukážka POMER BETÓN/ OTVOR
betón 85 % otvor 15 %

GALA

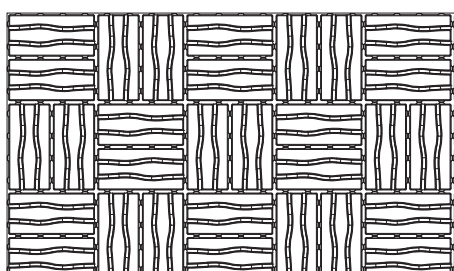

název
GALA orientáčná ukážka POMER BETÓN/ OTVOR
betón 85 % otvor 15 %

KARO EKO

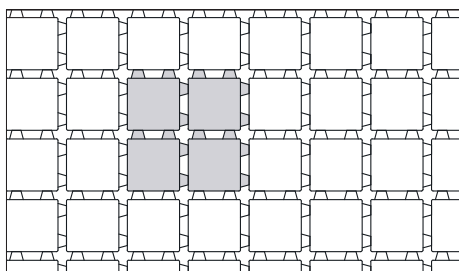

název
KARO EKO orientáčná ukážka POMER BETÓN/ OTVOR
betón 80,5 % otvor 19,5 %

PALLADIO EKO I

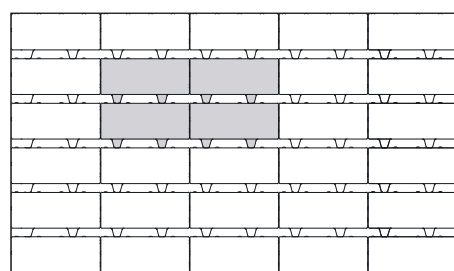

název
PALLADIO EKO I orientáčná ukážka POMER BETÓN/ OTVOR
betón 84,7 % otvor 15,3 %

PALLADIO EKO II

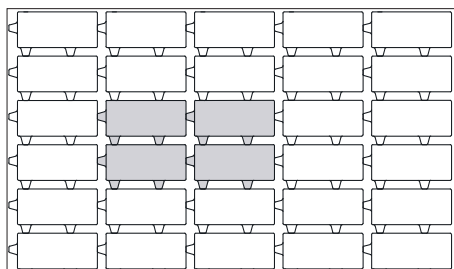

název
PALLADIO EKO II orientáčná ukážka POMER BETÓN/ OTVOR
betón 77,7 % otvor 22,3 %

PALLADIO EKO I

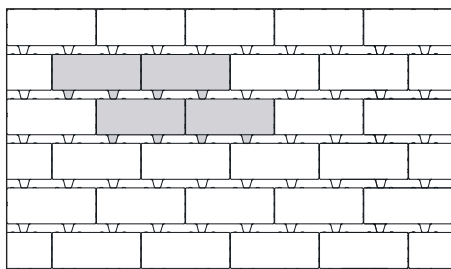

název
PALLADIO EKO I orientáčná ukážka POMER BETÓN/ OTVOR
betón 84,7 % otvor 15,3 %

GRAND

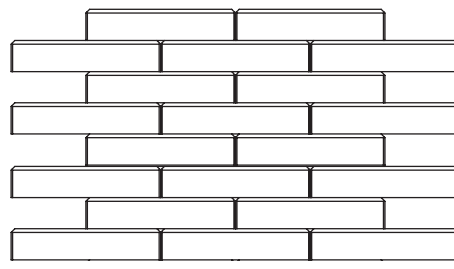

název
GRAND orientáčná ukážka

ZÁHONOVÝ SYSTÉM SPEKTRA

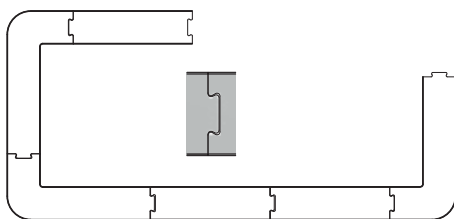

název
ZÁHONOVÝ SYSTÉM SPEKTRA prvky sa spájajú nasunutím na zámok

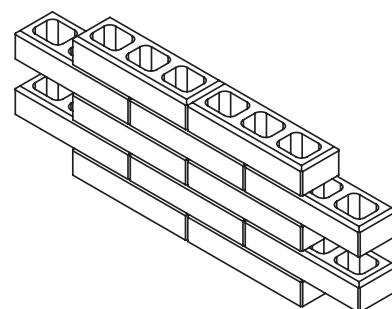
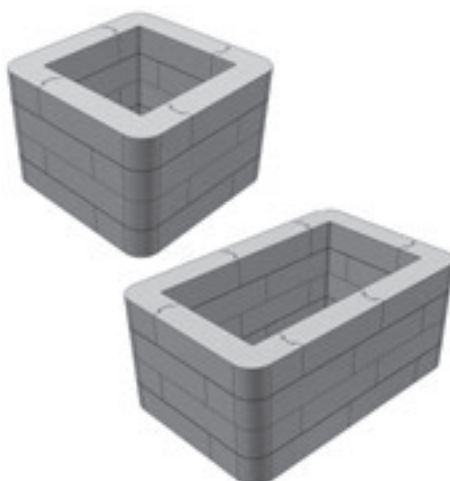

DOPORUČENÉ VZOROVÉ SKLADBY PODKLADOVÝCH VRSTV

DLAŽBY

CHODNÍKY

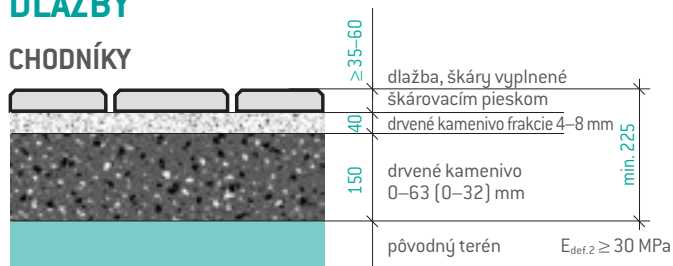

PLOCHY PRE ZAŤAŽENIE DO 3,5 T



PLOCHY PRE ZAŤAŽENIE NAD 3,5 T

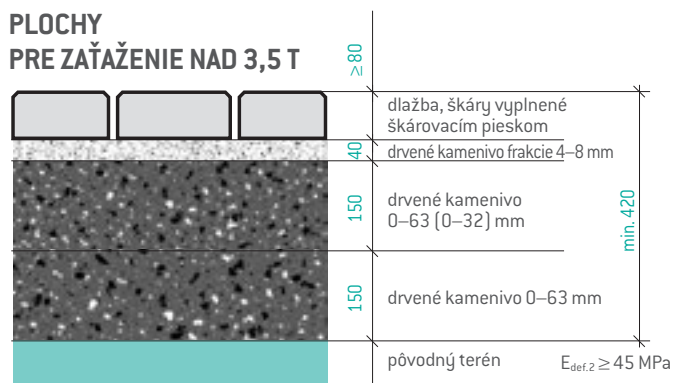

PLOŠNÉ DLAŽBY

POCHÔDZNE PLOCHY

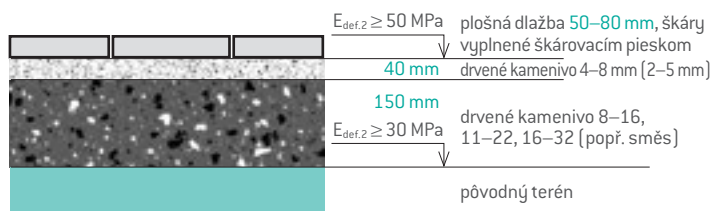

LAHKÁ AUTOMOBILOVÁ PREVÁDZKA PRI ŽELEZOBETÓNovej DOSKE

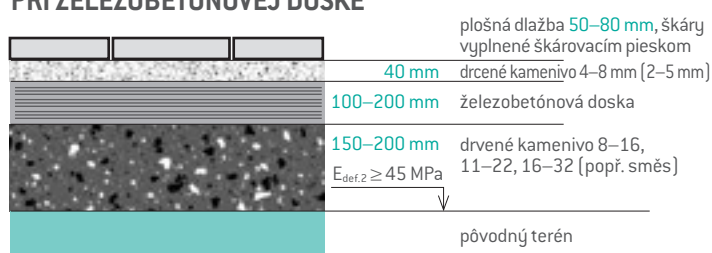

VEGETAČNÉ DLAŽBY

PLOCHY PRE ZAŤAŽENIE DO 3,5 T

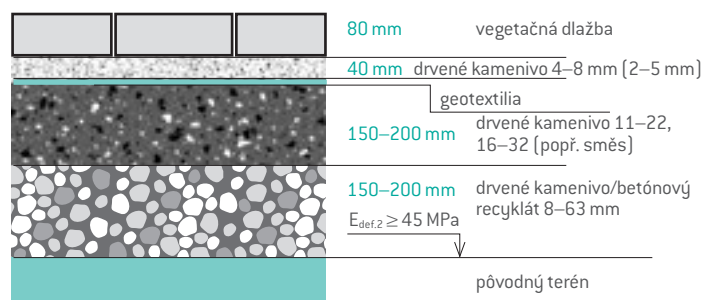

VODOPRIEPUSTNÉ DLAŽBY

POCHÔDZNE PLOCHY

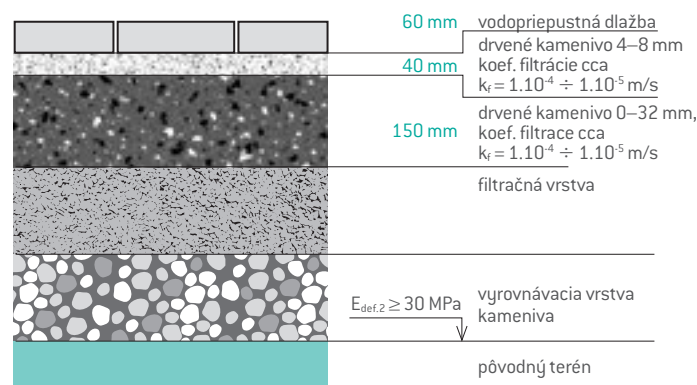

PLOCHY PRE ZAŤAŽENIE DO 3,5 T

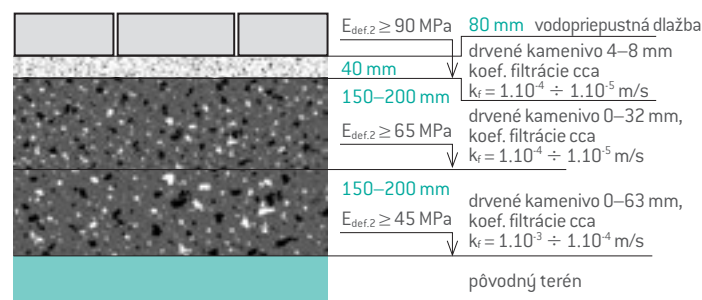

PLOCHY PRE ZAŤAŽENIE NAD 3,5 T

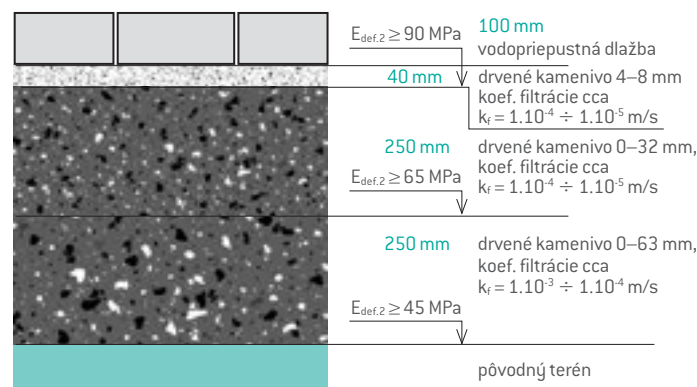

NÁVOD NA POKLÁDKU SCHODISKOVÉHO STUPŇA

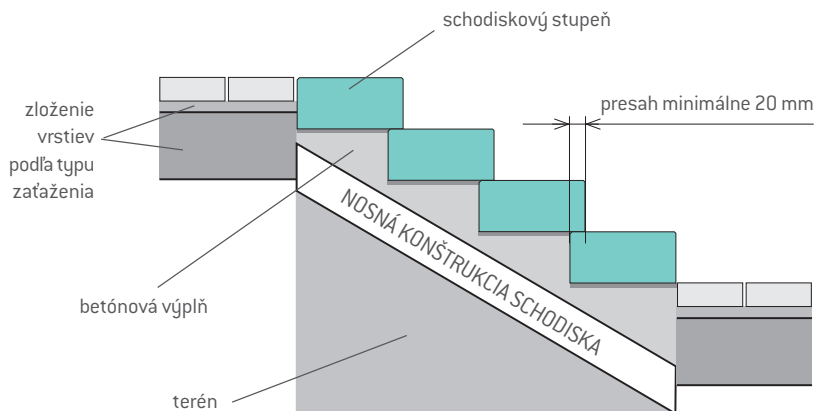

- stupeň je možné ukladať do vlhkej betónovej zmesi
- šírku nášlapu si môžete korigovať vzájomnou polohou schodov
- pri realizácii postupujete odspodu

KONŠTRUKCIE PLOTOV

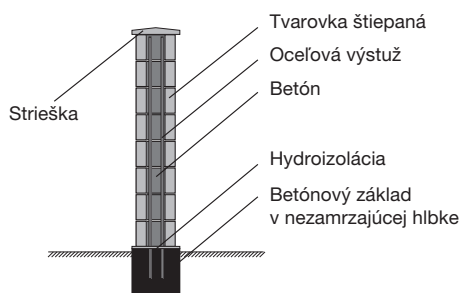

ZÁKLAD Z TVÁRNIC DEBNIACICH

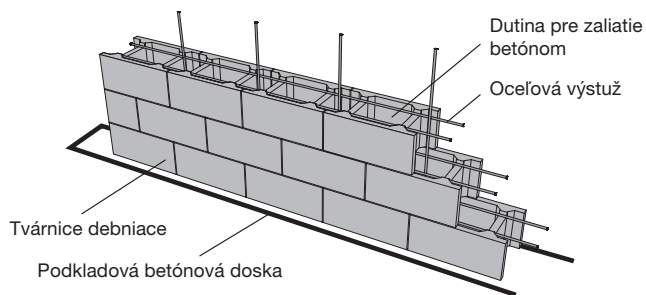

VYTVÁRANIE OBLÚKOV ZÁHRADNÝM KAMEŇOM

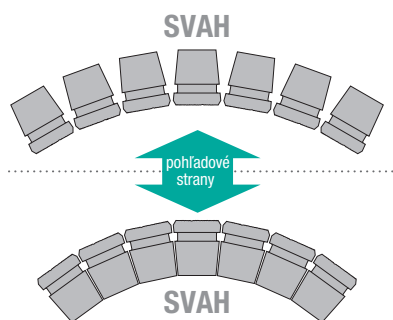

ULOŽENIE SVAHOVÝCH TVÁRNIC VARIO

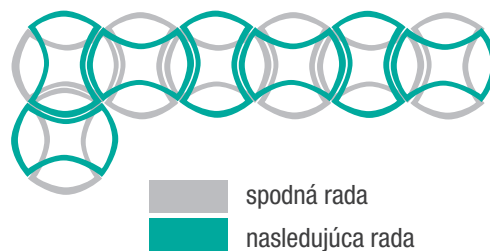



VYDANÉ 2025

AZbeton

VÝROBNÝ ZÁVOD CZ

687 12, Kněžpole 89
Česká republika
tel.: +420 572 588 023
e-mail: objednavky@azbeton.cz
info@azbeton.cz
www.azbeton.cz

VÝROBNÝ ZÁVOD SK

916 31, Kočovce 1065
Slovenská republika
tel.: +421 948 786 006
e-mail: objednavky@azbeton.sk
info@azbeton.sk
www.azbeton.sk |  [azbeton.sk](https://www.instagram.com/azbeton.sk)