

AZ**beton**



CENNÍK 2024
BETÓNOVÉ VÝROBKY

OBSAH

Úvod	2
Dlažby	3
Dlažba plošná	5
Dlažba vodopropustná.....	6
Dlažba vegetačná	6
Dlažba vibroliata	6
Odvodňovacie žľaby	6
Záhonový systém Spektra	7
Obrubníky vibrolisované	7
Obrubníky cestné, betónová príďlažba	8
Palisády	8
Obrubníky zastávkové	9
Schodiskový stupeň	9
Plotový systém	9
Tvárnice debniace	10
Tvárnice debniace s fazetou	10
Tvarovka murovacie s hladkým povrchom	10
Tvárnice murovacie	10
Plotové tvárnice Grand	10
Tvarovky štiepané	11
Plotové striešky k štiepaným tvarovkám	11
Plotové striešky, stípkové hlavice	11
Svahové tvárnice	12
Fasádny obklad	12
Komínové tvárnice, stípkové tvárnice	12
Balenie, vrátenie paliet	13
Upozornenie	13
Návody	14

IMPREGNÁCIA

Hĺbková impregnácia bráni prieniku vody a nečistôt. Výrobky sú potom menej náchylné na tvorbu vápenatých výkvetov, zelenanie povrchov a majú vyššiu odolnosť proti pôsobeniu mrazu a posypových solí. U všetkých výrobkov v prevedení colormix aplikujeme hĺbkovú impregnáciu EXTRA, ktorá predlžuje životnosť a zväčšuje farby.

VYSVETLIVKY



chemická odolnosť, mrazuvzdornosť,
dlhá životnosť



hĺbková impregnácia



hĺbková impregnácia EXTRA
(COLORMIX) – NOVINKA

FAREBNÉ PREVEDENIE

HLADKÝ POVRCH

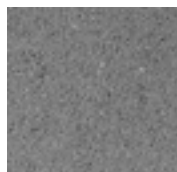

1 SIVÁ



2 ČERVENÁ



3 ŽLTÁ



4 ŠKORICOVÁ



5 HNEDÁ

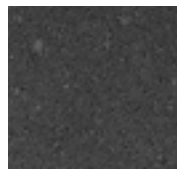

6 ČIERNA



7 BIELA

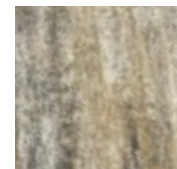

COLORMIX C1 – C10

ŠTIEPANÝ POVRCH



1 SIVÁ



2 ČERVENÁ

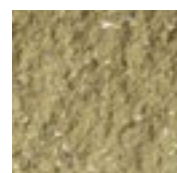

3 ŽLTÁ



4 ŠKORICOVÁ



5 HNEDÁ

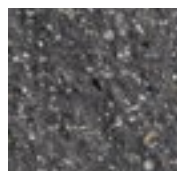

6 ČIERNA

COLORMIX



COLORMIX 1
BRILANT



COLORMIX 2
SILVER

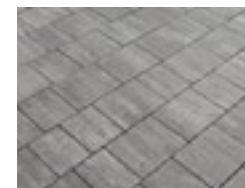

COLORMIX 3
ANTRACIT



COLORMIX 4
LAVA



COLORMIX 6
TERAKOTA



COLORMIX 7
ARABICA



COLORMIX 8
AURUM





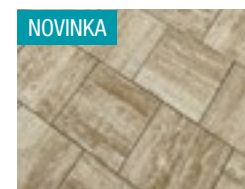

COLORMIX 9
BRONZ



COLORMIX 10
SAND

Tlačové chyby a zmeny vyhradené.





VÝROBOK		Rozmer	Spotreba	Na paletu	Sivá		Farebné prevedenie		Farebnosť
		(d × š × v) mm	ks/m ² kg/m ²	m ² kg	€/m ²	€/m ²	€/m ²	€/m ²	
BEHATON		198×162×40	36 90	11,67 1050	12,10	14,52	14,90	17,88	2-6
		198×162×100	36 225	6,42 1445	19,00	22,80	21,60	25,92	
BEHATON pre strojovú pokládku		198×162×80	36 180	7,34 1321	16,40	19,68	19,55	23,46	2-7
		198×162×60	36 135	10,10 1364	13,80	16,56	16,30	19,56	
BEHATON MARKET		198×162×80	36 180	6,67 1201	17,60	21,12	20,75	24,90	2-7
		198×162×60	36 135	9,17 1238	15,40	18,48	18,05	21,66	
BEHATON krajovka		198×140×100	- 225	231 ks 1300	0,57	0,69	0,63	0,75	2-7
		198×162×80	- 180	224 ks 1260	0,52	0,62	0,57	0,69	2-6
		198×162×60	- 135	330 ks 1340	0,48	0,57	0,53	0,64	2-6
BEHATON 1/2		99×162×80	72 180	576 ks 1440	0,28	0,34	0,32	0,39	2-6
		99×162×60	72 135	792 ks 1485	0,25	0,30	0,30	0,36	
BEHATON MARKET 1/2		99×162×80	72 180	576 ks 1440	0,28	0,34	0,32	0,39	2-6
		99×162×60	72 135	792 ks 1485	0,25	0,30	0,30	0,36	
HOLAND KLASIK		NOVINKA 200×100×100	50 225	5,76 1296	19,00	22,80	21,60	25,92	2, 6
		200×100×80	50 180	7,68 1382	16,40	19,68	19,55	23,46	
		200×100×60	50 135	10,56 1426	13,80	16,56	16,30	19,56	2-7
		200×100×40	50 90	12,48 1123	12,10	14,52	14,90	17,88	
HOLAND MARKET		200×100×80	50 180	7,68 1382	17,60	21,12	20,75	24,90	2-7
		200×100×60	50 135	10,56 1426	15,40	18,48	18,05	21,66	2-7
		200×100×45	50 100	12,48 1248	13,00	15,60	14,90	17,88	2-6
HOLAND HISTORY		200×100×60	50 135	10,56 1426	21,00	25,20	24,00	28,80	2-6
HOLAND PRE NEVIDIACICH		200×100×80	50 180	7,68 1382	27,50	33,00	29,40	35,28	2, 6
		200×100×60	50 135	10,56 1426	24,50	29,40	27,15	32,58	2, 6, 7
KOCKA 20×20 VODIACE DRÁŽKY		200×200×80	25 180	7,68 1382	27,00	32,40	29,75	35,70	2, 6
		200×200×60	25 135	10,56 1426	25,85	31,02	28,40	34,08	
KOCKA 30×30 KLASIK		300×300×80	11,1 180	8,65 1557	17,40	20,88	21,40	25,68	2-7
		300×300×60	11,1 135	10,90 1471	15,00	18,00	17,55	21,06	2-6
		300×300×45	11,1 100	13,00 1300	14,40	17,28	16,15	19,38	2-7
KOCKA 20×20 KLASIK		200×200×80	25 180	7,68 1382	17,50	21,00	19,80	23,76	2-7
		200×200×60	25 135	10,56 1426	13,80	16,56	16,30	19,56	
KOCKA 10×10 KLASIK		100×100×80	100 180	7,68 1382	16,85	20,22	19,80	23,76	2-6
		100×100×60	100 135	10,56 1426	13,85	16,62	17,40	20,88	
KOCKA 30×30 MARKET		300×300×80	11,10 180	8,65 1557	18,00	21,60	21,45	25,74	2-7
KOCKA 20×20 MARKET		200×200×80	25 180	7,68 1382	18,00	21,60	20,50	24,60	2-7
		200×200×60	25 135	10,56 1426	15,95	19,14	18,70	22,44	

VÝROBOK		Rozmer	Spotreba	Na palete	Sivá	Farebné prevedenie	Farebnosť				
		(d × š × v) mm	ks/m ² kg/m ²	m ² kg	€/m ²	€/m ²	€/m ²				
UNIDEKOR		230×140×80	38 180	8,42 1516	17,85	21,42	20,75	24,90	2-6		
		230×140×60	38 135	10,53 1422	15,65	18,78	18,05	21,66			
UNIDEKOR krajovka		230×90×60	- 135	440 ks 1300	0,50	0,60	0,54	0,65	2-6		
UNI		222×111×100	39 225	6,28 1413	20,95	25,14	23,70	28,44	2, 6		
		222×111×60	39 135	9,87 1332	15,65	18,78	18,05	21,66	2-6		
VLNKA		222×111×60	39 135	9,87 1332	15,65	18,78	18,05	21,66	2-6		
VÝROBOK		Rozmer	Spotreba	Na palete	Sivá	Farebné prevedenie 2-7	Colormix 				
		(d × š × v) mm	ks/m ² kg/m ²	m ² kg	€/m ²	€/m ²	€/m ²				
BRANDENBURGER*		140×70×60	- 135					22,20 I C1 C4 C7	26,64 I C1 C4 C7		
		140×140×60	- 135	10,35 1397	16,00	19,20	18,80			22,56	
		140×210×60	- 135								
MOZAIKA*		110×60-135	- 135	10,13 1368	16,20	19,44	-	-	-		
VÝROBOK		Rozmer	Spotreba	Na palete	Sivá	Farebné prevedenie 2,6	Colormix 				
ROCHUZ (mikrofazeta)	NOVINKA		160×240×100	26 225	5,76 1296	21,00	25,20	24,00	28,80	-	-
VÝROBOK		Rozmer	Spotreba	Na palete	Sivá	Farebné prevedenie 2-6	Colormix 				
ROCHUZ MARKET		160×240×60	26 135	10,56 1426	16,70	20,04	20,00	24,00	23,45 I C1 C2 C4 C7	28,14 I C1 C2 C4 C7	
		160×160×60	39 135	11,26 1520	16,70	20,04	20,00	24,00			
ROCHUZ HISTORY		160×240×80	26 180	7,40 1332	22,50	27,00	25,80	30,96	-	-	
		160×240×60	26 135	10,56 1426	21,00	25,20	24,00	28,80	-	-	
		160×160×60	39 135	11,26 1520	21,00	25,20	24,00	28,80	-	-	
VÝROBOK		Rozmer	Spotreba	Na palete	Sivá	Farebné prevedenie 2-7	Colormix 				
BUCHLOV*		132×191×60	- 135								
		149×191×60	- 135	9,24 1247	16,00	19,20	19,50	23,40	22,70 I C3 C4 C7 C10	27,24 I C3 C4 C7 C10	
		225×191×60	- 135								
TREND *		300×300×60	- 135								
		200×300×60	- 135						24,20 I C2 C3 C6 C8 C9 C10	29,04 I C2 C3 C6 C8 C9 C10	
		200×200×60	- 135	10,56 1426	17,50	21,00	-	-			
		200×100×60	- 135								

* predaj po vrstvách

** pri farebnom prevedení BIELA účtujeme k cene bez DPH príplatok € 1,40/m²

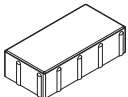
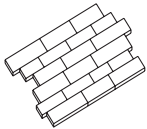
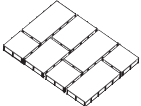
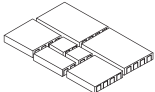
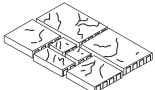
cena bez DPH cena s DPH

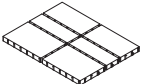



VÝROBOK		Rozmer	Spotreba	Na palete	Sivá		Farebné prevedenie 2, 6		Colormix 		
					€/m ²	€/m ²	€/m ²	€/m ²	€/m ²	€/m ²	
		(d × š × v) mm	ks/m ² kg/m ²	m ² kg	€/m ²	€/m ²	€/m ²	€/m ²	€/m ²	€/m ²	
PALLADIO (malá fazeta)	NOVINKA		300×150×80	22,22 180	7,20 1296	18,80	22,56	21,50	25,80	25,00 C2 C8 C9	30,00 C2 C8 C9
LINEA*		240, 270, 330, 360×130×60	- 135	11,88 1604	17,30	20,76	-	-	24,20 C2, C8, C9	29,04 C2, C8, C9	
		360, 390, 450×150×60	- 135								
		360, 390, 450×170×60	- 135								
CREATIV* (mikrofazeta)	NOVINKA		600×300×60	- 135	11,88 1604	19,00	22,80	-	-	25,70 C2 C3 C8 C9 C10	30,84 C2 C3 C8 C9 C10
			450×300×60	- 135							
			300×300×60	- 135							
BECKOV MARKET*		600×400×60	- 135	10,56 1426	17,30	20,76	-	-	24,20 C6 C9 C10	29,04 C6 C9 C10	
		400×400×60	- 135								
		400×200×60	- 135								
		200×200×60	- 135								
BECKOV*		600×400×60	- 135	10,56 1426	17,30	20,76	-	-	24,20 C2 C8	29,04 C2 C8	
		400×400×60	- 135								
		400×200×60	- 135								
		200×200×60	- 135								
ČACHTICE*			- 12 ks výška 80 mm	- 180	6,72 1210	18,80	22,56	-	-	24,95 C3 C9	29,94 C3 C9
HARMONY* (mikrofazeta)	NOVINKA		600×400×80	- 180	7,56 1361	18,80	22,56	-	-	25,00 C2, C8, C9, C10	30,00 C2 C8 C9, C10
			600×200×80	- 180							
			600×300×80	- 180							

* predaj po vrstvách

cena bez DPH cena s DPH

DLAŽBA PLOŠNÁ

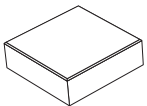
Skupina A





VÝROBOK		Rozmer	Spotreba	Na palete	Sivá		Farebné prevedenie 2-6		Colormix 		
					€/m ²	€/m ²	€/m ²	€/m ²	€/m ²	€/m ²	
		(d × š × v) mm	ks/m ² kg/m ²	m ² kg	€/m ²	€/m ²	€/m ²	€/m ²	€/m ²	€/m ²	
DLAŽBA PLOŠNÁ VIBROLISOVANÁ		600×400×80	4,17 180	7,70 1386	21,20	25,44	24,50	29,40	-	-	
		500×500×80	4 180	7 1260	20,10	24,12	23,70	28,44	-	-	
		500×500×60	4 135	10 1350	17,30	20,76	20,00	24,00	-	-	
		800×400×50 malá fazeta	3,13 110	7,68 845	20,00	24,00			29,00 C2 C3 C8 C9	34,80 C2 C3 C8 C9	
		NOVINKA									
		Rozmer	Spotreba	Na palete	Sivá			Farebné prevedenie 2-7	Colormix 		
		500×500×50 malá fazeta	4 110	10 1100	16,20	19,44	18,50	22,20	29,00 C2 C10	34,80 C2 C10	
		400×400×50 malá fazeta	6,25 110	7,68 845	16,20	19,44	18,50	22,20	29,00 C2 C3 C8	34,80 C2 C3 C8	

*pri farebnom prevedení BIELA účtujeme k cene bez DPH príplatok € 1,40/m²

cena bez DPH cena s DPH

DLAŽBA VODOPRUPSTNÁ



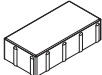

Skupina A

VÝROBOK	 	Rozmer	Spotreba	Na palete	Sivá	Farebné prevedenie 2, 6		
		(d × š × v) mm	ks/m ² kg/m ²	m ² kg	€/m ²	€/m ²	€/m ²	€/m ²
HOLAND HYDRO 10 NOVINKA		200×100×100	50 225	5,76 1296	37,00	44,40	40,00	48,00
HOLAND HYDRO 8 NOVINKA		200×100×80	50 180	7,68 1382	34,00	40,80	38,00	45,60
HOLAND HYDRO 6 NOVINKA		200×100×60	50 135	10,56 1426	31,00	37,20	34,00	40,80
KOSTKA HYDRO 8 NOVINKA		200×200×80	25 180	7,68 1382	34,00	40,80	38,00	45,60
KOSTKA HYDRO 6 NOVINKA		200×200×60	25 135	10,56 1426	31,00	37,20	34,00	40,80
ROCHUZ HYDRO NOVINKA		160×240×100	26 225	5,76 1296	37,00	44,40	40,00	48,00
PALLADIO HYDRO NOVINKA		300×150×80	22 180	7,20 1296	34,00	40,80	38,00	45,60

cena bez DPH cena s DPH

DLAŽBA VEGETAČNÁ

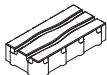



Skupina A

VÝROBOK	 	Rozmer	Spotreba	Na palete	Sivá	Farebné prevedenie		Farebnosť	
		(d × š × v) mm	ks/m ² kg/m ²	m ² kg	€/m ²	€/m ²	€/m ²	€/m ²	
GALA NOVINKA		400×200×80	12,50 145	7,68 1114	19,70	23,64	21,70	26,04	2, 6
KARO		200×200×80	25 160	7,68 1229	19,70	23,64	21,70	26,04	2-6
		(d × š × v) mm	ks/m ² kg/ks	ks kg	€/ks	€/ks	€/ks	€/ks	
DLAŽBA ZATRÁVŇOVACIA		600×400×100	4,17 35	32 1120	5,20	6,24	6,70	8,04	2-5
		600×400×80	4,17 28	40 1120	3,90	4,68	5,65	6,78	2-5

cena bez DPH cena s DPH

DLAŽBA VIBROLIATA



Skupina B

VÝROBOK		Rozmer	Spotreba	Hmotnosť	Na palete	Sivá	Farebné prevedenie 2-5		
		(d × š × v) mm	ks/m ² kg/m ²	kg/ks	ks	€/ks	€/ks	€/ks	€/ks
DOSKA 58×20×4		580×200×40	8,60 83	10	kusový predaj	7,00	8,40	7,85	9,42
DOSKA 20×20×4		200×200×40	25 83	3,33	kusový predaj	2,80	3,36	3,10	3,72
						Sivá	Farebné prevedenie 4		
DOSKA 79×35×5		790×350×50	3,61 100	28	kusový predaj	8,10	9,72	10,00	12,00
DOSKA 79×19×5		790×190×50	6,66 100	15	kusový predaj	4,35	5,22	5,50	6,60

cena bez DPH cena s DPH

ODVODŇOVACIE ŽLABY





Skupina B

VÝROBOK		Rozmer	Spotreba	Na palete	Sivá	Farebné prevedenie		
		(d × š × v) mm	ks/bm kg/ks	ks	€/ks	€/ks	€/ks	€/ks
ODVODŇOVACÍ ŽLAB veľký		350×250×80	2,80 12	kusový predaj	3,80	4,56	-	-
ODVODŇOVACÍ ŽLAB malý		255×160×80	3,90 6	kusový predaj	3,45	4,14	-	-

cena bez DPH cena s DPH

ODVODŇOVACIE ŽĽABY

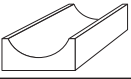



Skupina A

VÝROBOK	 	Rozmer	Spotreba	Na palete	Sivá	
ŽĽABY VIBROLISOVANÉ		(d × š × v) mm	ks/bm kg/ks	ks/kg	€/ks	€/ks
ŽĽAB ODVODŇOVACÍ 50	NOVINKA 	500×250×100	2 25	48 1200	4,60	5,52
CESTNÝ ŽĽAB ODVODŇOVACÍ 33		330×650×160	3 43	24 1032	4,35	5,22
CESTNÝ ŽĽAB ODVODŇOVACÍ 25	NOVINKA 	250×500×120	4 25	36 900	3,10	3,72

cena bez DPH cena s DPH

ZÁHONOVÝ SYSTÉM SPEKTRA

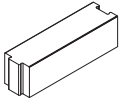













Skupina B

VÝROBOK	 	Rozmer	Hmotnosť	Na palete	Sivá	Čierná	
		(d × v × š) mm	kg/ks	ks/kg	€/ks	€/ks	€/ks
ZÁHONOVÝ SYSTÉM SPEKTRA, priebežný	NOVINKA 	500×150×140	22	48 1056	5,00	6,00	5,40
ZÁHONOVÝ SYSTÉM SPEKTRA, rohový	NOVINKA 	600×150×140	32	32 1024	6,40	7,68	7,00

cena bez DPH cena s DPH

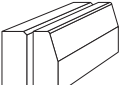
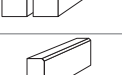
OBRUBNÍKY VIBROLISOVANÉ







Skupina B

VÝROBOK	 	Rozmer	Spotreba	Na palete	Sivá	Farebné prevedenie 2-5	
		(d × v × š) mm	ks/bm kg/ks	ks/kg	€/ks	€/ks	€/ks
OBRUBNÍK ZÁHRADNÝ P+D 20 POLOGULATÝ		500×200×50	2 10	90 900	1,90	2,28	-
OBRUBNÍK ZÁHRADNÝ P+D 20 GULATÝ		500×200×50	2 10	90 900	1,90	2,28	2,50
OBRUBNÍK ZÁHRADNÝ P+D 25 GULATÝ		500×250×50	2 12,5	90 1125	2,25	2,70	-
OBRUBNÍK ZÁHRADNÝ P+D 20 ROVNÝ	NOVINKA 	500×200×50	2 10	90 900	1,90	2,28	-
OBRUBNÍK ZÁHRADNÝ P+D 20 ROVNÝ, DLHÝ	NOVINKA 	1000×200×50	1 20	48 960	3,38	4,06	-
OBRUBNÍK ZÁHRADNÝ P+D 25 ROVNÝ, DLHÝ	NOVINKA 	1000×250×50	1 25	45 1125	3,85	4,62	-
OBRUBNÍK ZÁHRADNÝ P+D 20 DLHÝ		1000×200×50	1 20	48 960	3,38	4,06	4,40
OBRUBNÍK ZÁHRADNÝ P+D 25 DLHÝ		1000×250×50	1 25	45 1125	3,85	4,62	-
OBRUBNÍK CHODNÍKOVÝ rovný 25		1000×250×100	1 54	24 1296	6,00	7,20	-
OBRUBNÍK CHODNÍKOVÝ skosený		1000×250×100	1 51	24 1224	6,00	7,20	-
OBRUBNÍK CHODNÍKOVÝ rovný 20		1000×200×100	1 43	24 1032	5,75	6,90	-
OBRUBNÍK PARKOVÝ		1000×250×75	1 40	30 1200	5,40	6,48	-
		(d × š × v) mm	ks/bm kg/ks	ks kg	€/ks	€/ks	€/ks
TRÁVNIKOVÝ LEM		330×160×50	3 5	200 1000	1,10	1,32	1,35

cena bez DPH cena s DPH

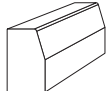
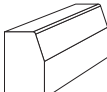
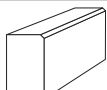
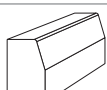
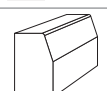
OBRUBNÍKY CESTNÉ, BETÓNOVÁ PRÍDLAŽBA

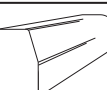
Skupina B

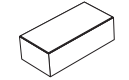
VÝROBOK	 	Rozmer	Spotreba	Na palete	Sivá	
		(d × v × š) mm	ks/bm kg/ks	ks/kg	€/ks	€/ks
OBRUBNÍK CESTNÝ 30		1000×300×150	1 96	15 1440	8,90	10,68
OBRUBNÍK CESTNÝ 25		1000×250×150	1 80	15 1200	6,80	8,16
OBRUBNÍK CESTNÝ 25 PREMIUM		1000×250×150	1 80	15 1200	6,80	8,16
OBRUBNÍK CESTNÝ 25 ROVNÝ		1000×250×150	1 80	15 1200	6,80	8,16
OBRUBNÍK CESTNÝ 1/2		500×250×150	2 40	32 1280	5,00	6,00
OBRUBNÍK CESTNÝ 1/3		330×250×150	3 27	30 810	4,20	5,04
OBRUBNÍK CESTNÝ 1/3 PREMIUM		330×250×150	3 27	30 810	4,20	5,04
OBRUBNÍK NÁJAZDOVÝ		1000×150×150	1 50	24 1200	6,50	7,80
OBRUBNÍK PRECHODOVÝ L+P		1000×250×150	1 65	9+9 1170	22,35	26,82



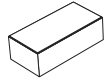

Skupina A







VÝROBOK		Rozmer	Spotreba	Na palete	Sivá	
		(d × š × v) mm	ks/bm kg/ks	ks kg	€/ks	€/ks
BETÓNOVÁ PRÍDLAŽBA		500×250×100	2 29	48 1392	3,40	4,08
		500×250×80	2 23	48 1104	3,15	3,78

cena bez DPH cena s DPH

PALISÁDY

Skupina B







VÝROBOK	 	Rozmer	Spotreba	Na palete	Sivá		Farebné prevedenie 2-5			
		(š × v) mm	ks/bm kg/ks	ks kg	€/ks	€/ks	€/ks	€/ks	€/ks	€/ks
KRUHOVÁ PALISÁDA 50		120×500	10 13	66 858	4,05	4,86	5,15	6,18	-	-
KRUHOVÁ PALISÁDA 30		120×300	10 8	66 528	2,40	2,88	3,15	3,78	-	-

VÝROBOK	 	Rozmer	Spotreba	Na palete	Sivá		Čierna	Colormix C2 		
		(d × š × v) mm	ks/bm kg/ks	ks kg	€/ks	€/ks	€/ks	€/ks	€/ks	
PALISÁDA 120		180×120×1200	5,55 57	20 1140	15,80	18,96	18,00	21,60	19,00	22,80
PALISÁDA 80	NOVINKA	180×120×800	5,55 38	30 1140	9,80	11,76	11,00	13,20	12,00	14,40
PALISÁDA 60		180×120×600	5,55 28,5	40 1140	7,70	9,24	8,80	10,56	9,40	11,28
PALISÁDA 40		180×120×400	5,55 19	60 1140	3,70	4,44	4,25	5,10	4,50	5,40
ŠTIEPANÁ PALISÁDA 80/10	NOVINKA	150×100×800	6,66 24	40 960	10,60	12,72	13,00	15,60	-	-
ŠTIEPANÁ PALISÁDA 60/10		150×100×600	6,66 20	48 960	7,20	8,64	8,70	10,44	-	-
ŠTIEPANÁ PALISÁDA 40/10		150×100×400	6,66 13	80 1040	4,80	5,76	5,80	6,96	-	-
ŠTIEPANÁ PALISÁDA 110/15	NOVINKA	150×150×1100	6,66 49,50	20 990	16,20	19,44	19,40	23,28	-	-
ŠTIEPANÁ PALISÁDA 60/15		150×150×600	6,66 30	36 1080	10,80	12,96	13,00	15,60	-	-
ŠTIEPANÁ PALISÁDA 40/15		150×150×400	6,66 20	56 1120	7,30	8,76	8,65	10,38	-	-

cena bez DPH cena s DPH

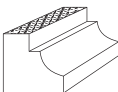
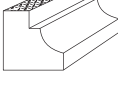
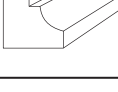
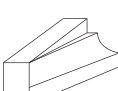
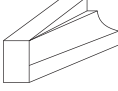
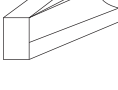
OBRUBNÍKY ZASTÁVKOVÉ

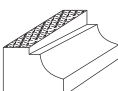
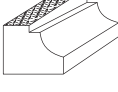

Skupina B

VÝROBOK	 	Rozmer	Hmotnosť	Na palete	Sivá	
		(d × š × v) mm	kg/ks	ks/kg	€/ks	€/ks
OBRUBNÍK ZASTÁVKOVÝ priamy 29		1000×400×290	224	3 672	129,20	155,04
OBRUBNÍK ZASTÁVKOVÝ priamy 33		1000×400×330	242	3 726	129,20	155,04
OBRUBNÍK ZASTÁVKOVÝ priamy 37		1000×400×370	261	3 783	129,20	155,04
OBRUBNÍK ZASTÁVKOVÝ prechodový 25-29 L		1000×400×250-290	147	2 294	129,20	155,04
OBRUBNÍK ZASTÁVKOVÝ prechodový 25-29 P		1000×400×250-290	147	2 294	129,20	155,04
OBRUBNÍK ZASTÁVKOVÝ prechodový 25-31 L		1000×400×250-310	151	2 302	129,20	155,04
OBRUBNÍK ZASTÁVKOVÝ prechodový 25-31 P		1000×400×250-310	151	2 302	129,20	155,04
OBRUBNÍK ZASTÁVKOVÝ nábehový 31-33 L		1000×400×310-330	236	2 472	129,20	155,04
OBRUBNÍK ZASTÁVKOVÝ nábehový 31-33 P		1000×400×310-330	236	2 472	129,20	155,04
OBRUBNÍK ZASTÁVKOVÝ nábehový 31-37 L		1000×400×310-370	247	2 494	129,20	155,04
OBRUBNÍK ZASTÁVKOVÝ nábehový 31-37 P		1000×400×310-370	247	2 494	129,20	155,04

cena bez DPH cena s DPH

SCHODISKOVÝ STUPEŇ



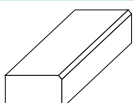
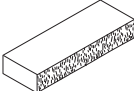
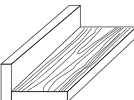



Skupina B

VÝROBOK	 	Rozmer	Spotreba	Na palete	Sivá		Čierna	
		(d × š × v) mm	ks/bm kg/ks	ks/kg	€/ks	€/ks	€/ks	€/ks
SCHODISKOVÝ STUPEŇ		900×340×150	- 95	8 760	24,60	29,52		
SCHODISKOVÝ STUPEŇ SO ŠTĪPANÝM ČELOM	NOVINKA 	1200×350×150	- 139	8 1112	33,95	40,74	40,60	48,72
SCHODISKOVÝ STUPEŇ TYP DOSKA		850×400×155	- 45	12 540	20,50	24,60	-	-

cena bez DPH cena s DPH

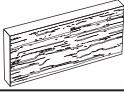
PLOTOVÝ SYSTÉM

Skupina B

VÝROBOK		Rozmer	Hmotnosť	Na palete	Sivá	
		(d × š × v) mm	kg/ks	ks kg	€/ks	€/ks
PLOTOVÝ DIEL KAMEŇ, OBLÚKOVÝ		2000×50×610	90	kusový predaj	29,60	35,52
PLOTOVÝ DIEL KAMEŇ		2000×50×500	80	15 1200	24,60	29,52
STĹPIK PRIEBEŽNÝ		1650×160×130	58,50	kusový predaj	30,75	36,90
		2400×160×130	85	kusový predaj	44,30	53,16
		3300×160×130	117	kusový predaj	59,00	70,80
STĹPIK ROHOVÝ		2400×160×130	90	kusový predaj	44,30	53,16
STĹPIK KONCOVÝ		2400×160×130	90	kusový predaj	44,30	53,16
PODHRABOVÁ DOSKA		2500×300×40	52	15 780	19,70	23,64

Plotový systém - výrobok je určený na ďalšiu povrchovú úpravu a je armovaný.

cena bez DPH cena s DPH

TVÁRNICE DEBNIACE

Skupina B

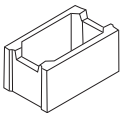
VÝROBOK		Rozmer	Spotreba	Na palete	Sivá	
		(d × š × v) mm	ks/m ² kg/ks	ks kg	€/ks	€/ks
TVÁRNICA PRESNÁ DEBNIACA 10		490×100×250	8 17	80 1360	2,10	2,52
TVÁRNICA PRESNÁ DEBNIACA 15		500×150×250	8 18	80 1440	2,10	2,52
TVÁRNICA PRESNÁ DEBNIACA 20		500×200×250	8 24	60 1440	2,30	2,76
TVÁRNICA PRESNÁ DEBNIACA 25		500×250×250	8 28	40 1120	2,55	3,06
TVÁRNICA PRESNÁ DEBNIACA 30		500×300×250	8 31	40 1240	2,66	3,19
TVÁRNICA PRESNÁ DEBNIACA 40		500×400×250	8 37	30 1110	3,11	3,73
TVÁRNICA PRESNÁ DEBNIACA 50		400×500×250	10 37	20 740	3,61	4,33

cena bez DPH cena s DPH

TVÁRNICE DEBNIACE S FAZETOU

Skupina B

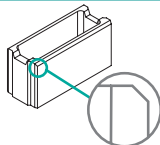

VÝROBOK		Rozmer	Spotreba	Na palete	Sivá	
		(d × š × v) mm	ks/m ² kg/ks	ks kg	€/ks	€/ks
BLOK 20 S FAZETOU		500×200×250	8 24	60 1440	2,50	3,00

NOVINKA

cena bez DPH cena s DPH

TVAROVKY MUROVACIE S HLADKÝM POVRCHOM

Skupina B

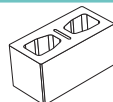
VÝROBOK	 	Rozmer	Spotreba	Na palete	Sivá		Farebné prevedenie 2-5	
		(d × š × v) mm	ks/m ² kg/ks	ks kg	€/ks	€/ks	€/ks	€/ks
TVAROVKA HLADKÁ ODĽAHČENÁ		385×190×190	13,50 18	60 1080	3,10	3,72	3,90	4,68

cena bez DPH cena s DPH

TVÁRNICE MUROVACIE



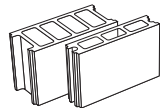



Skupina B

VÝROBOK		Rozmer	Spotreba	Na palete	Sivá	
		(d × š × v) mm	ks/m ² kg/ks	ks kg	€/ks	€/ks
TVÁRNICA MUROVACIA S DNOM		450×100×200	11,10 12,5	100 1250	1,66	1,99
		450×200×200	11,10 23	50 1150	2,60	3,12

cena bez DPH cena s DPH

PLOTOVÉ TVÁRNICE GRAND

Skupina B









VÝROBOK	 	Rozmer	Spotreba	Na palete	Sivá		Farebné prevedenie 6		
		(d × š × v) mm	ks/m ² kg/ks	ks kg	€/ks	€/ks	€/ks	€/ks	
PLOTOVÁ TVÁRNICA GRAND	NOVINKA		200×200×125	40 6	192 1152	1,60	1,92	2,40	2,88
PLOTOVÁ TVÁRNICA GRAND	NOVINKA		400×200×125	20 12	96 1152	3,00	3,60	3,80	4,56
PLOTOVÁ TVÁRNICA GRAND	NOVINKA		600×200×125	13,3 18	64 1152	4,60	5,52	5,40	6,48
PLOTOVÁ TVÁRNICA GRAND, stĺpová	NOVINKA		400×300×125	20 17	64 1088	4,00	4,80	4,80	5,76
PLOTOVÁ STRIEŠKA rovná GRAND	NOVINKA		230×270×55	ks/bm kg/ks 4,3 7,5	162 1215	3,50	4,20	3,90	4,68

Plotová tvárnica GRAND v ponuke od 1. 5. 2024

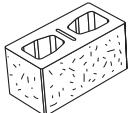
cena bez DPH cena s DPH

TVAROVKY ŠTIEPANÉ





Skupina B

VÝROBOK		Rozmer	Spotreba	Na palete	Sivá		Farebné prevedenie 2-6		
					(d × š × v) mm	ks/m ² kg/ks	ks kg	€/ks	€/ks
TVAROVKA 1-STRANNÁ			385×190×190	13,50 18	60 1080	3,30	3,96	3,80	4,56
TVAROVKA 2-STRANNÁ						4,40	5,28	5,00	6,00
TVAROVKA ROHOVÁ						4,70	5,64	5,20	6,24
TVAROVKA 3-STRANNÁ, stĺpová						5,90	7,08	6,50	7,80
TVAROVKA 3-STRANNÁ, koncová						5,90	7,08	6,50	7,80
TVAROVKA 4-STRANNÁ						7,00	8,40	7,70	9,24
TVAROVKA PRIMUROVACIA		385×65×190	13,50 10	150 1500	1,35	1,62	1,60	1,92	

cena bez DPH cena s DPH

PLOTOVÉ STRIEŠKY K ŠTIEPANÝM TVAROVKÁM





Skupina B

VÝROBOK		Rozmer	Spotreba	Na palete	Sivá		Farebné prevedenie 2-6 *	
					(d × š) mm	ks/bm kg/ks	ks kg	€/ks
PLOTOVÁ STRIEŠKA s odkvapovou drážkou		220×380	4,50 8,5	84 714	3,30	3,96	3,85	4,62
PLOTOVÁ STRIEŠKA so štiepaným čelom		220×300	4,50 7,4	168 1243	3,70	4,44	4,30	5,16
PLOTOVÁ STRIEŠKA veľká s odkvapovou drážkou		190×580	5,25 11	84 924	4,65	5,58	5,20	6,24
PLOTOVÁ STRIEŠKA veľká so štiepaným čelom		190×500	5,25 10	84 840	5,00	6,00	5,75	6,90

* farebné prevedenie ČIERNA - iba na objednávku

PLOTOVÉ STRIEŠKY, STĽPOVÉ HLAVICE

Skupina B

VÝROBOK		Rozmer	Spotreba	Na palete	Sivá		Farebné prevedenie 6		Prevedenie
					(d × š) mm	ks/bm kg/ks	ks kg	€/ks	
PLOTOVÁ STRIEŠKA rovná GRAND		230×270×55	4,3 7,5	162 1215	3,50	4,20	3,90	4,68	
PLOTOVÁ STRIEŠKA vibroliata 50×18		500×180	2 9	kusový predaj	5,55	6,66	7,10	8,52	HL -
PLOTOVÁ STRIEŠKA vibroliata 39×27		390×270	2,50 9	61 549	6,10	7,32	7,60	9,12	HL DR
PLOTOVÁ STRIEŠKA vibroliata 39×35		390×350	2,50 12,50	30 375	6,95	8,34	8,55	10,26	HL DR
PLOTOVÁ STRIEŠKA vibroliata 70×46		700×460	1,40 50	kusový predaj	27,00	32,40	32,90	39,48	HL -
STĽPOVÁ HLAVICA vibroliata 49×27		490×270	- 13	kusový predaj	-	-	11,70	14,04	HL -
STĽPOVÁ HLAVICA vibroliata 47×27 *		470×270	- 13	kusový predaj	9,50	11,40	11,70	14,04	- DR
STĽPOVÁ HLAVICA vibroliata 39×39		390×390	- 15,50	kusový predaj	7,00	8,40	9,25	11,10	- DR
STĽPOVÁ HLAVICA vibroliata 49×49		490×490	- 25	kusový predaj	9,95	11,94	11,80	14,16	HL DR
STĽPOVÁ HLAVICA vibroliata 55×55		550×550	- 28	kusový predaj	10,45	12,54	12,45	14,94	HL -





HL - hladký povrch, DR - drsný povrch

* iba na objednávku: HL | - SIVÁ a prevedenie - | DR SIVÁ, ČERVENÁ, ŽLTÁ, ŠKORICOVÁ, HNEDÁ

cena bez DPH cena s DPH

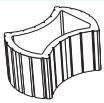
SWAHOVÉ TVÁRNICE

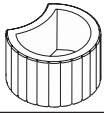

Skupina B

VÝROBOK		Rozmer	Spotreba	Na palete	Sivá		Farebné prevedenie 2-5	
		(d × š × v) mm	ks/m ² kg/ks	ks kg	€/ks	€/ks	€/ks	€/ks
SWAHOVÁ TVÁRNICA VARIO		570×385×250	10 44	20 880	8,95	10,74	10,75	12,90
SWAHOVÁ TVÁRNICA KRUHOVÁ		ø345 280×200	17,50 18	30 540	4,35	5,22	5,40	6,48
SWAHOVÁ TVÁRNICA KRUHOVÁ VEĽKÁ		ø 500 420×250	9,50 45	20 900	7,20	8,64	9,00	10,80
ZÁHRADNÝ KAMEŇ		225×200×100	50 9	140 1260	1,95	2,34	2,20	2,64

cena bez DPH cena s DPH

FASÁDNÝ OBKLAD



Skupina B

VÝROBOK	 	Rozmer	Spotreba	Na palete	Sivá		Farebné prevedenie 2-5	
		(d × š × v) mm	ks/m ² kg/m ²	m ² kg	€/m ²	€/m ²	€/m ²	€/m ²
FASÁDNÝ OBKLAD ŠTIEPANÝ		220×50×35	90,90 66,36	-	22,00	26,40	23,00	27,60

cena bez DPH cena s DPH

KOMÍNOVÉ TVÁRNICE, STĽPIKOVÉ TVÁRNICE

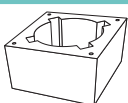
Skupina B

VÝROBOK		Rozmer	Spotreba	Na palete	Sivá	
		(d × š × v) mm	ks/bm kg/ks	ks kg	€/ks	€/ks
KERAMZITOVÁ KOMÍNOVÁ TVÁRNICA, ø20 cm		400×400×250	4 28	30 840	8,10	9,72
KERAMZITOVÁ KOMÍNOVÁ TVÁRNICA, ø16 cm		320×320×250	4 18	40 720	7,70	9,24
BETÓNOVÁ STĽPIKOVÁ TVÁRNICA ŠTVORCOVÁ 40		400×400×250	4 32	30 960	3,90	4,68
BETÓNOVÁ STĽPIKOVÁ TVÁRNICA ŠTVORCOVÁ 30		300×300×250	4 20	60 1200	3,00	3,60
BETÓNOVÁ STĽPIKOVÁ TVÁRNICA ŠTVORCOVÁ 20		200×200×250	4 12	96 1152	2,40	2,88
BETÓNOVÁ STĽPIKOVÁ TVÁRNICA KRUHOVÁ		ø300×250	4 12	40 480	2,40	2,88

cena bez DPH cena s DPH

BALENIE, VRÁTENIE PALIET

Tovar expedujeme na paletách EUR.

PALETA EUR

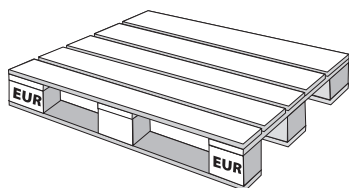

Účtované v cene pri odbere palet (od 1. 5. 2022)

15 EUR / 1 ks +DPH

Čiastka vrátená pri vrátení použitých palet
a pri predložení zálohového listu na palety (od 1. 5. 2022)

13 EUR / 1 ks +DPH

ROZBALENIE PALETY

10 EUR | paleta

VRÁTENIE PALIET

Nepoškodené palety sú vratné **do 3 mesiacov od expedície**.

Palety je možné vracať iba pri doložení dokladu VRATKA PALET alebo ZÁLOHOVÉHO LISTU NA PALETY

Kupujúci je povinný vrátiť palety na vlastné náklady.

V prípade, ak sa domnievate, že Vám bol tovar dodaný na poškodenej palete, musí byť pri preberaní tovaru táto skutočnosť poznačená do dodacieho listu, alebo iného dokladu.

Za poškodenú sa považuje paleta so zlomenou, alebo chýbajúcou doskou, prípadne paleta, ktorej chýba niektorá ďalšia významná časť a nie je možné ju už ďalej použiť.

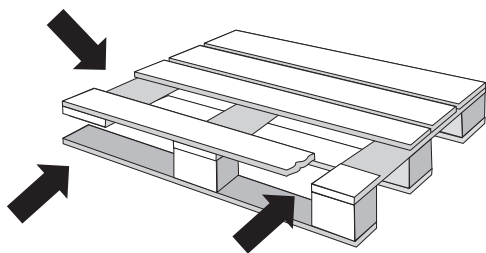

DOPRAVA

Zabezpečujeme rozvoz výrobkov vlastnými autami s hydraulickou rukou s možnosťou pripojenia návesu.

NOVINKA PRE COLORMIX

Híbková
impregnácia
EXTRA



UPOZORNENIE

Aby sme zabránili nedorozumeniam a zbytočným reklamáciám, venujte prosím pozornosť nasledovným upozorneniam.

„VÝKVVETY“

(VYZRÁŽANIE SOLÍ A VÁPENCA NA POVRCHU BETÓNU)

Pri technologickom procese spracovania betónovej zmesi dochádza v niektorých prípadoch pri odparovaní vody k vysrážaniu vápenca na povrchu betónu. Tieto „výkvvety“ **v žiadnom prípade neovplyvňujú úžitkové vlastnosti výrobku**. Pri bežných poveternostných vplyvoch počasia sa vápnik pomaly stráca, prípadne odplavuje a „výkvvety“ sa postupne po určitom čase sami stratia. Z uvedeného vyplýva, že „výkvvety“ **nemôžu byť predmetom reklamácie**.

ROZDIELY VO FARBE

Farebné betónové výrobky sú výrobky z prírodných materiálov, preto sa u nich mažu vyskytnúť menšie alebo väčšie rozdiely vo farebnosti. Dôležitým faktorom je aj vplyv cementu a farby kameniva. I napriek dôslednej kontrole vo výrobnom procese môžu vzniknúť rozdiely vo farbe výrobkov. Z týchto dôvodov **nemôžu byť farebné rozdiely v odtieňoch dôvodom k reklamácii**. Rozdiely farieb sú pre kvalitu výrobku bezvýznamné, pretože **poveternostnými vplyvmi počasia a samotným používaním miznú** a plocha ostáva rovnomerne farebná. Pri pokládke dlažby doporučujeme odoberať dlažbové kocky z viacerých palet (dlažbu vo farbe colormix odberať naraz z viacerých palet po celých vrstvách), prípadné rozdiely v odtieni potom nepôsobia rušivo.

DOSTUPNOSŤ TOVARU

U farebných výrobkov v požadovanom množstve menšom, ako 1 paleta (okrem zámkovej dlažby a štiepaných tvaroviek) upresňujeme termín dodania individuálne.

OLUPOVANIE HRÁN

Ak sa betónová dlažba ukladá na doraz a spodná vrstva nie je dostatočne zhutnená, vzniká nebezpečie, že pri vibráciách a následnom zaťažení plochy budú hrany dlažby vystavené veľkému tlaku, ktorému ani betóny najvyšších tried a kvality nie sú schopné odolat. Výsledkom sú **odlomené hrany**, čo **nie je chyba výrobku**, ale chyba uloženia. Dlažba sa musí ukladať podľa technických podkladov projektanta. Dodávateľ stavebných prác tak ručí za odborné prevedenie pokládky. Dlažba sa vždy kladie do lôžka z kvalitného drveného kameniva (2–4 mm, prípadne 4–8 mm). Plné zaťaženie dlažby a ostatných betónových výrobkov je možné najskôr po 28 dňoch od dátumu výroby. **Pri nedodržaní týchto pokynov firma AZ BETON nezodpovedá za vady vzniknuté nesprávnou pokládkou, predčasným zaťažením, alebo nevhodným určením druhu dlažby pre komunikácie**. Návod na pokládku zámkovej dlažby nájdete v katalógu AZ BETON.

PLOŠNÉ DLAŽBY

{300×300 mm, 400×400 mm, 500×500 mm} a dlažby zatravnovacie nie je možné zhutniť vibračnou doskou. Dosadenie dlažby na lôžko z kameniva 4–8 mm sa prevádza gumovým kladivkom cez drevenú dosku.

REKLAMÁCIE

Reklamácie prípadných väd je možné uplatniť iba pred použitím výrobkov.

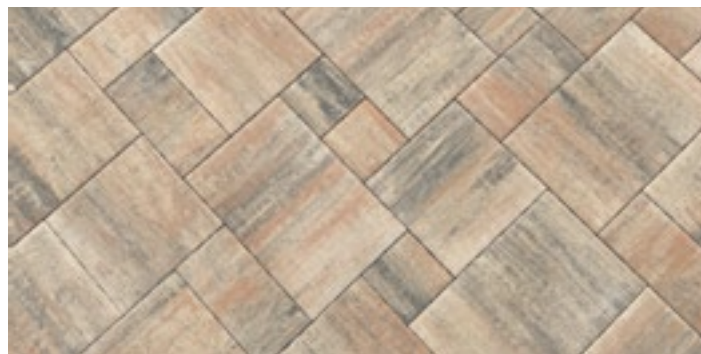

TREND

VARIANTY POKLÁDKY

ČACHTICE

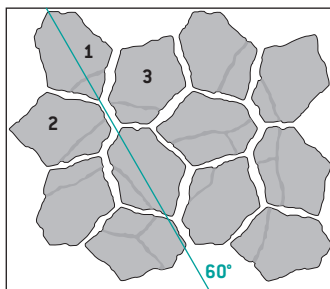

názov pokládka

ČACHTICE Kamene kladieme v poradí 1, 2, 3 a ďalej pokračujeme tak, aby sa tri najkratšie strany vždy zbiehali v jeden bod, vid. nákres.

BRANDENBURGER

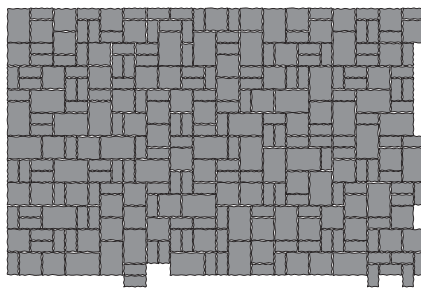

názov BRANDENBURGER orientačná ukážka

ROCHUZ

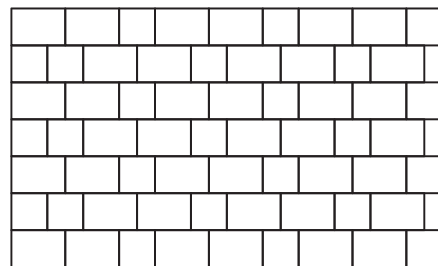

názov	rozmer	farba	ks	podiel (%)
ROCHUZ	160×160	-	9,75	25,0
ROCHUZ	160×240	-	19,5	75,0

LINEA

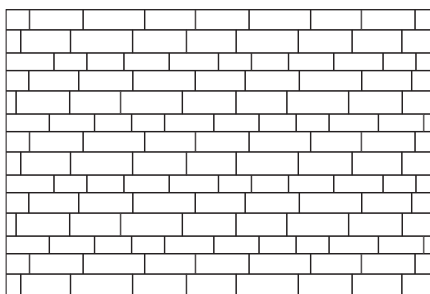

názov LINEA orientačná ukážka

TREND

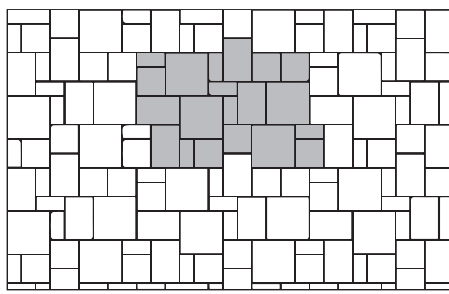

názov TREND orientačná ukážka

TREND

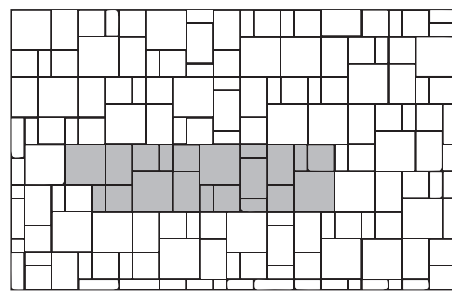

názov TREND orientačná ukážka

BUCHLOV

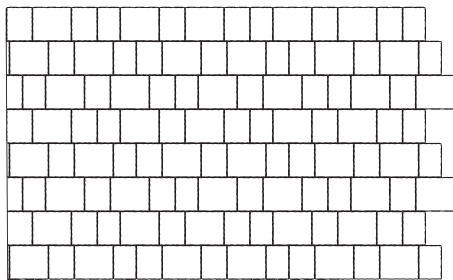

názov BUCHLOV orientačná ukážka

BECKOV, BECKOV MARKET

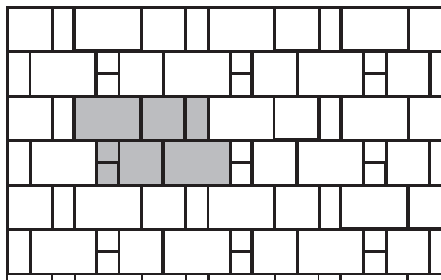

názov BECKOV orientačná ukážka

BECKOV, BECKOV MARKET

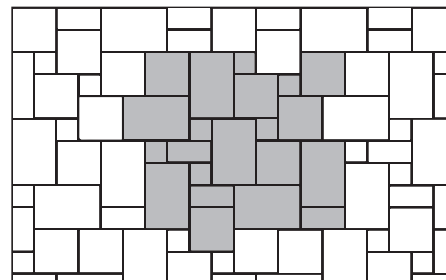

názov BECKOV orientačná ukážka

CREATIV

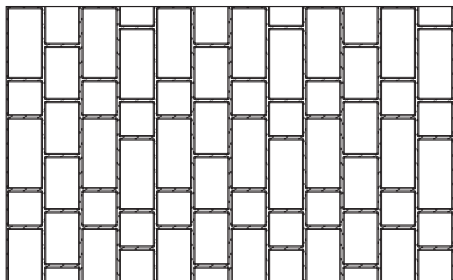

názov CREATIV orientačná ukážka

HARMONY

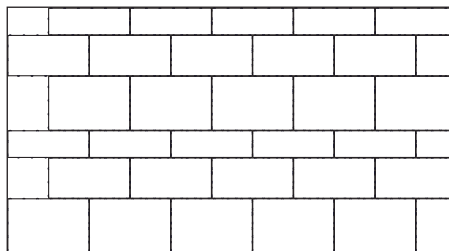

názov HARMONY orientačná ukážka

HARMONY

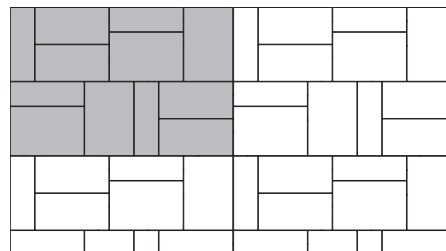

názov HARMONY orientačná ukážka

HARMONY

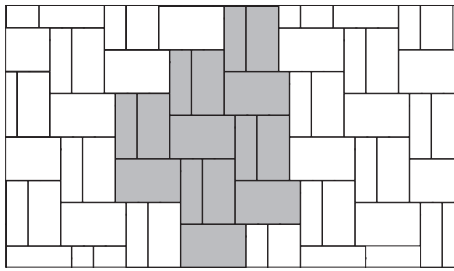

názov

HARMONY

orientačná ukážka

GRAND

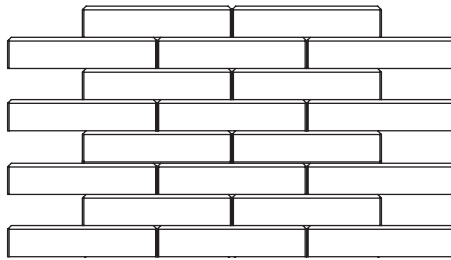

názov

GRAND

orientačná ukážka

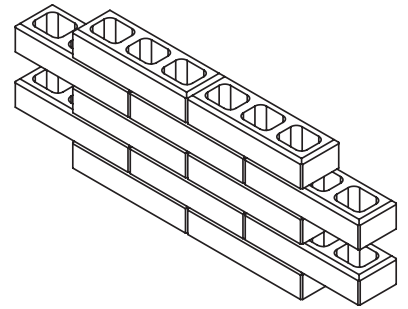

ZÁHONOVÝ SYSTÉM SPEKTRA

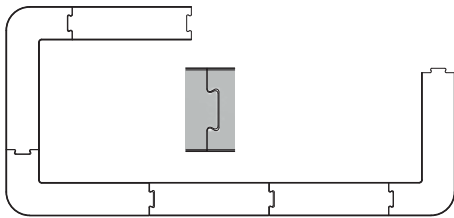

názov

ZÁHONOVÝ SYSTÉM SPEKTRA

prvky sa spájajú nasunutím na zámok

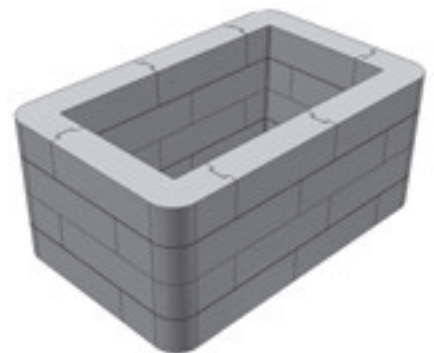

KONŠTRUKCIE PLOTOV

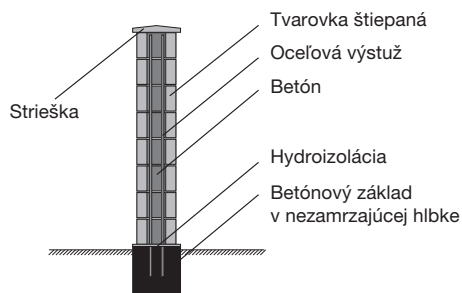

ZÁKLAD Z TVÁRNIC DEBNIACICH

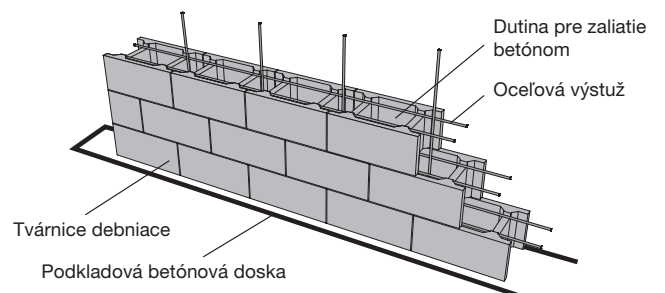

VYTVÁRANIE OBLÚKOV ZÁHRADNÝM KAMEŇOM

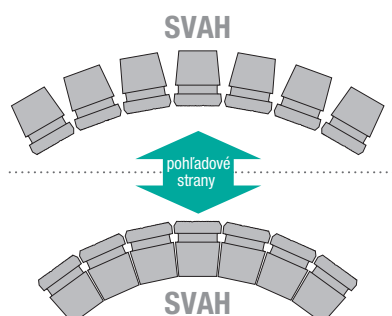

ULOŽENIE SVAHOVÝCH TVÁRNIC VARIO





AZbeton

VÝROBNÝ ZÁVOD CZ

687 12, Kněžpole 89
Česká republika
tel.: +420 572 588 023
e-mail: objednavky@azbeton.cz
info@azbeton.cz
www.azbeton.cz

VÝROBNÝ ZÁVOD SK

916 31, Kočovce 1065
Slovenská republika
tel.: +421 948 786 006
e-mail: objednavky@azbeton.sk
info@azbeton.sk
www.azbeton.sk |  [azbeton.sk](https://www.instagram.com/azbeton.sk)

VYDANÉ 2024